



**Zawiasy • Podnośniki**  
**Hinges • Lifts**  
**Петли • Подъёмники**

## Zawias GTV. Drzwi nakładane

GTV hinge. Lift-off door / Петля GTV. Наружные дверцы

Index: ZP-BICN09...  
(\*)(\*\*)

### Cechy produktu / Features / Характеристика товара:

- Dostępny na zamówienie także w kolorze stare złoto.  
Also available in antique brass color.  
Доступен под заказ также в цвете старого золота.
- \* Dostępne wysokości prowadnika H=0, H=2  
\* Available slider heights H=0, H=2  
\* Высота ответной планки H=0, H=2
- \*\* W sprzedaży z eurokręćkami (ZE) lub bez (BE)  
\*\* Available on sale with or without Euro screws  
\*\* В продаже имеются с евро шурупа (ZE) и без евро шурупа (BE)
- \*\*\* Dostępny także w rozstawie 48  
\*\*\* Available also in span of 48  
\*\*\* Доступны также с расстоянием между отверстиями крепления 48 мм
- Dostępny na zamówienie w wersji rozkręconej (oddzielnie zawias, oddzielnie prowadnik)  
Available to order in dismantled version (hinge separately, slider separately)  
В продаже доступны также отдельно (отдельно петля, отдельно ответная планка к петле)

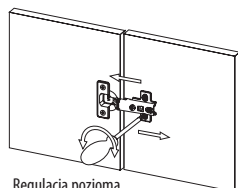

Regulacja pozioma  
Horizontal adjustment  
Регулировка по горизонтали

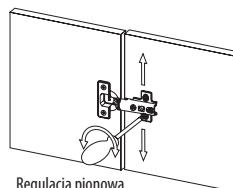

Regulacja pionowa  
Vertical adjustment  
Регулировка по вертикали

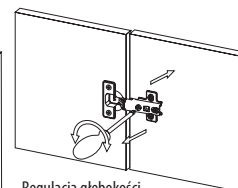

Regulacja głębokości  
Depth adjustment  
Регулировка глубины

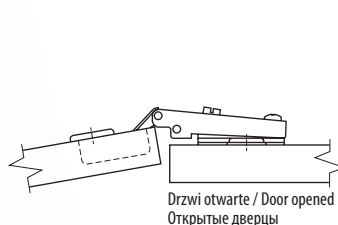

Drzwi otwarte / Door opened  
Открытые дверцы

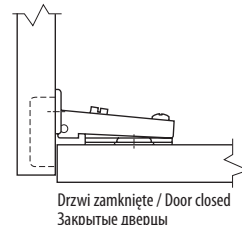

Drzwi zamknięte / Door closed  
Закрытые дверцы

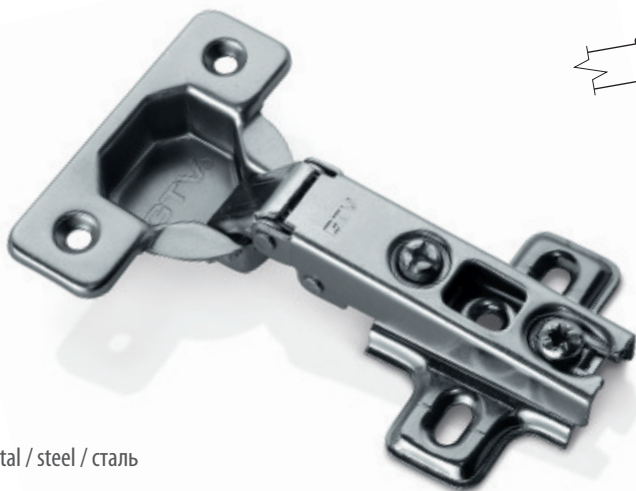

stal / steel / сталь

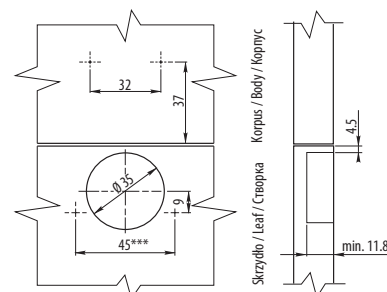

## Zawias GTV. Drzwi bliźniacze

GTV hinge. Twin door / Петля GTV. Двойные дверцы

Index: ZP-BICN08...  
(\*)(\*\*)

### Cechy produktu / Features / Характеристика товара:

- Dostępny na zamówienie także w kolorze stare złoto.  
Also available in antique brass color.  
Доступен под заказ также в цвете старого золота.
- \* Dostępne wysokości prowadnika H=0, H=2  
\* Available slider heights H=0, H=2  
\* Высота ответной планки H=0, H=2
- \*\* W sprzedaży z eurokręćkami (ZE) lub bez (BE)  
\*\* Available on sale with or without Euro screws  
\*\* В продаже имеются с евро шурупа (ZE) и без евро шурупа (BE)
- \*\*\* Dostępny także w rozstawie 48  
\*\*\* Available also in span of 48  
\*\*\* Доступны также с расстоянием между отверстиями крепления 48 мм
- Dostępny na zamówienie w wersji rozkręconej (oddzielnie zawias, oddzielnie prowadnik)  
Available to order in dismantled version (hinge separately, slider separately)  
В продаже доступны также отдельно (отдельно петля, отдельно ответная планка к петле)

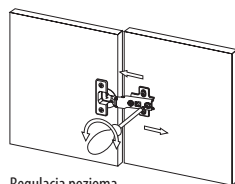

Regulacja pozioma  
Horizontal adjustment  
Регулировка по горизонтали

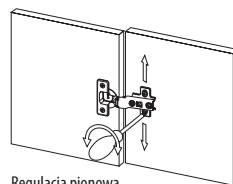

Regulacja pionowa  
Vertical adjustment  
Регулировка по вертикали

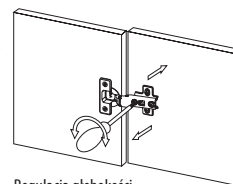

Regulacja głębokości  
Depth adjustment  
Регулировка глубины



Drzwi otwarte / Door opened  
Открытые дверцы

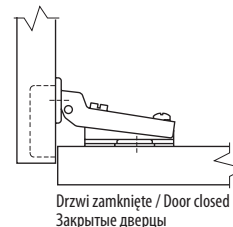

Drzwi zamknięte / Door closed  
Закрытые дверцы

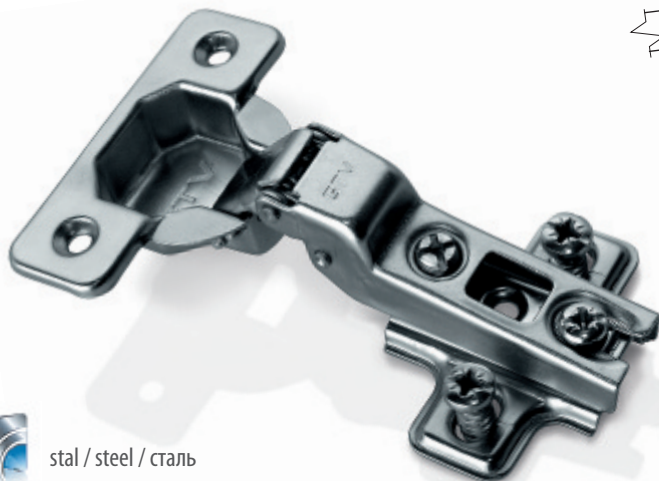

stal / steel / сталь

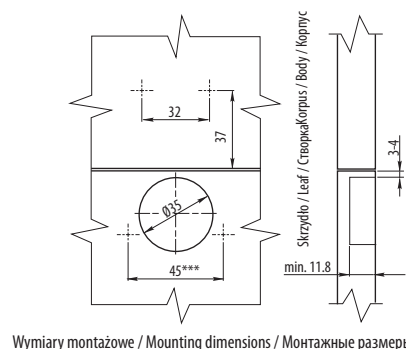

## Zawias GTV. Drzwi wpuszczane

Index: ZP-BICN07...  
(\*)(\*\*)

GTV hinge. Flush door / Петля GTV. Внутренние дверцы

### Cechy produktu / Features / Характеристика товара:

- Dostępny na zamówienie także w kolorze stare złoto.  
Also available in antique brass color.  
Доступен под заказ также в цвете старого золота.
- \* Dostępne wysokości prowadnika H=0, H=2  
\* Available slider heights H=0, H=2  
\* Высота ответной планки H=0, H=2
- \*\* W sprzedaży z eurokrętami (ZE) lub bez (BE)  
\*\* Available on sale with or without Euro screws  
\*\* В продаже имеются с евро шурупа (BE)
- \*\*\* Dostępny także w rozstawie 48  
\*\*\* Available also in span of 48  
\*\*\* Доступны также с расстоянием между отверстиями крепления 48 мм
- Dostępny na zamówienie w wersji rozkręconej (oddzielnie zawias, oddzielnie prowadnik)  
Available to order in dismantled version (hinge separately, slider separately)  
В продаже доступны также отдельно (отдельно петля, отдельно ответная планка к петле)

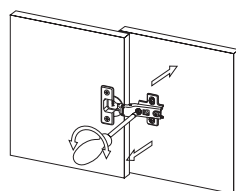

Regulacja pozioma  
Horizontal adjustment  
Регулировка по горизонтали

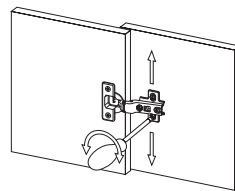

Regulacja pionowa  
Vertical adjustment  
Регулировка по вертикали

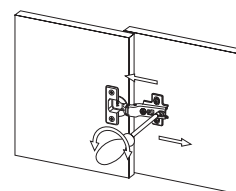

Regulacja głębokości  
Depth adjustment  
Регулировка глубины

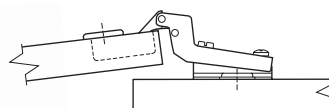

Drzwi otwarte / Door opened  
Открытые дверцы

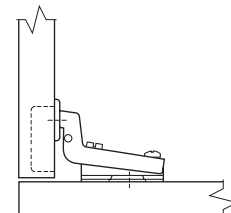

Drzwi zamknięte / Door closed  
Закрытые дверцы

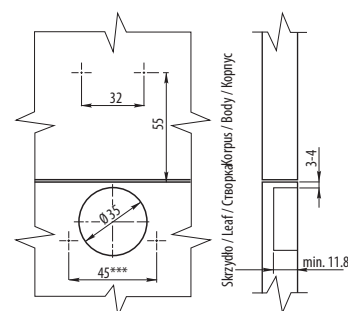

stal / steel / сталь



## Zawias GTV mini. Drzwi nakładane

Index: ZP-CI09H0...  
(\*)

GTV hinge, mini. Lift-off door / Петля GTV мини. Наружные дверцы

### Cechy produktu / Features / Характеристика товара:

- Dostępne wysokości prowadnika H=0  
Available slider heights H=0  
Высота ответной планки H=0
- \* W sprzedaży z eurokrętami (ZES) lub bez (-BE)  
\* Available on sale with (ZES) or without (-BE) Euro screws  
\* В продаже имеются с евро (ZES) и без евро шурупа (-BE)

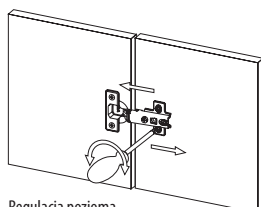

Regulacja pozioma  
Horizontal adjustment  
Регулировка по горизонтали

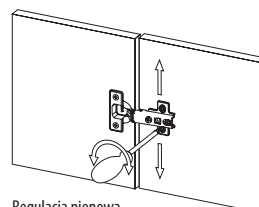

Regulacja pionowa  
Vertical adjustment  
Регулировка по вертикали

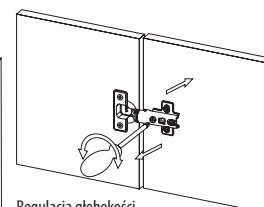

Regulacja głębokości  
Depth adjustment  
Регулировка глубины

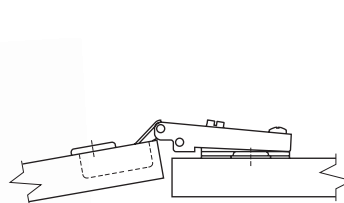

Drzwi otwarte / Door opened  
Открытые дверцы

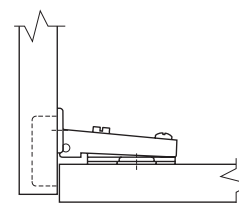

Drzwi zamknięte / Door closed  
Закрытые дверцы

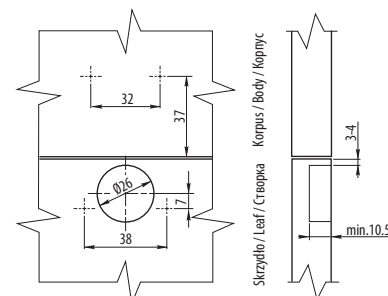

stal / steel / сталь

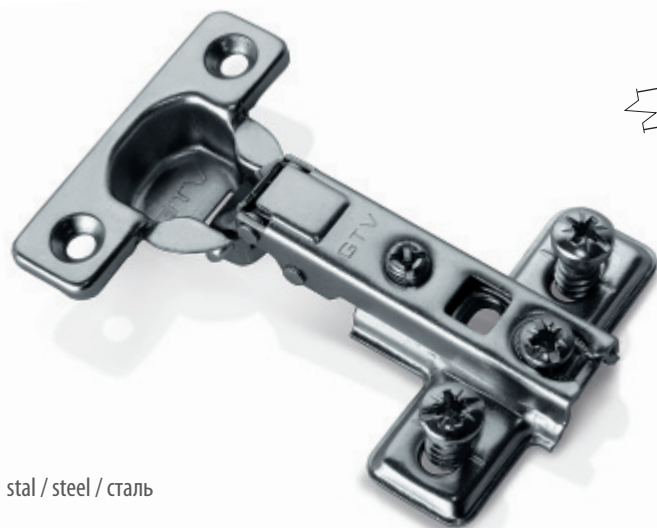

## Zawias GTV mini. Drzwi bliźniacze

GTV hinge, mini. Twin door / Петля GTV мини. Двойные дверцы

Index: ZP-CI08H0... (\*)

### Cechy produktu / Features / Характеристика товара:

- Dostępne wysokości prowadnika H=0  
Available slider heights H=0  
Высота ответной планки H=0
- \* W sprzedaży z eurowkrętami (ZES) lub bez (-BE)  
\* Available on sale with (ZES) or without (-BE) Euro screws  
\* В продаже имеются с евро (ZES) и без евро шурупа (-BE)

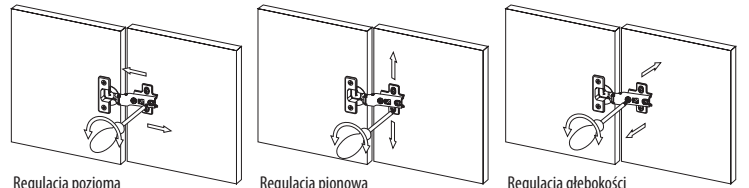

Regulacja pozioma  
Horizontal adjustment  
Регулировка по горизонтали

Regulacja pionowa  
Vertical adjustment  
Регулировка по вертикали

Regulacja głębokości  
Depth adjustment  
Регулировка глубины



stal / steel / сталь

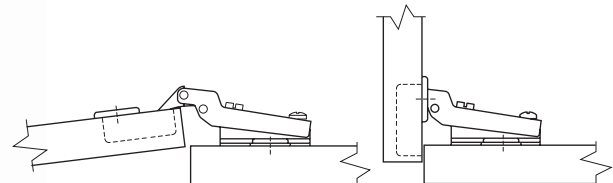

Drzwi otwarte / Door opened  
Открытые дверцы

Drzwi zamknięte / Door closed  
Закрытые дверцы

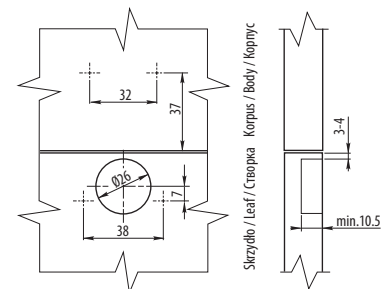

Wymiary montażowe / Mounting dimensions / Монтажные размеры

## Zawias GTV mini. Drzwi wpuszczane

GTV hinge, mini. Flush door / Петля GTV мини. Внутренние дверцы

Index: ZP-CI07H0... (\*)

### Cechy produktu / Features / Характеристика товара:

- Dostępne wysokości prowadnika H=0  
Available slider heights H=0  
Высота ответной планки H=0
- \* W sprzedaży z eurowkrętami (ZES) lub bez (-BE)  
\* Available on sale with (ZES) or without (-BE) Euro screws  
\* В продаже имеются с евро (ZES) и без евро шурупа (-BE)

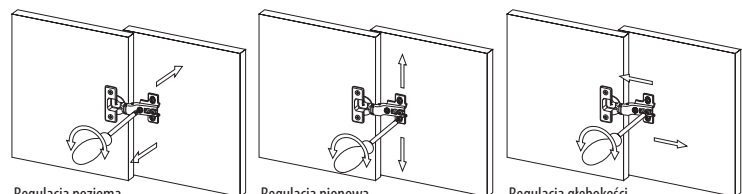

Regulacja pozioma  
Horizontal adjustment  
Регулировка по горизонтали

Regulacja pionowa  
Vertical adjustment  
Регулировка по вертикали

Regulacja głębokości  
Depth adjustment  
Регулировка глубины



stal / steel / сталь

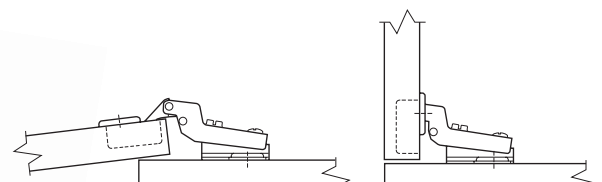

Drzwi otwarte / Door opened  
Открытые дверцы

Drzwi zamknięte / Door closed  
Закрытые дверцы

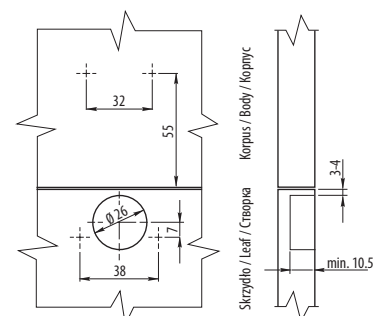

Wymiary montażowe / Mounting dimensions / Монтажные размеры

## Zawias GTV kątowy 30°

Index: ZP-KT30H2-... (\*)

GTV hinge, angular 30° / Угловая петля GTV 30°

### Cechy produktu / Features / Характеристика товара:

- Dostępny na zamówienie także w kolorze stare złoto. Also available in antique brass color. Доступен под заказ также в цвете старого золота.
- \* W sprzedaży z eurowkrętami (ZE) lub bez (BE) \* Available on sale with (ZE) or without (BE) Euro screws \* В продаже имеются с евро (ZE) и без евро шурупа (BE)
- Dostępne wysokości prowadnika H=2 Available slider heights H=2 Высота ответной планки H=2

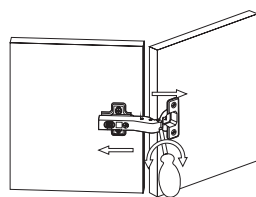

Regulacja pozioma  
Horizontal adjustment  
Регулировка по горизонтали

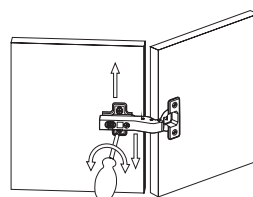

Regulacja pionowa  
Vertical adjustment  
Регулировка по вертикали

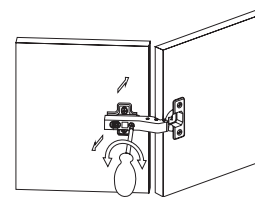

Regulacja głębokości  
Depth adjustment  
Регулировка глубины



stal / steel / сталь

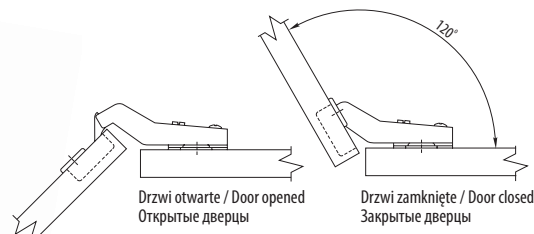

Drzwi otwarte / Door opened  
Открытые дверцы

Drzwi zamknięte / Door closed  
Закрытые дверцы

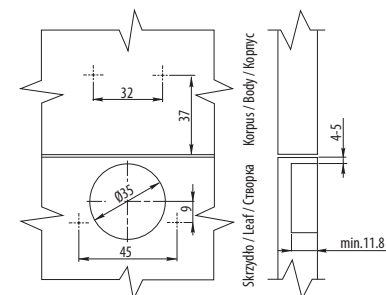

Wymiary montażowe / Mounting dimensions / Монтажные размеры

## Zawias GTV kątowy 45°

Index: ZP-KT45H2-... (\*)

GTV hinge, angular 45° / Угловая петля GTV 45°

### Cechy produktu / Features / Характеристика товара:

- Dostępny na zamówienie także w kolorze stare złoto. Also available in antique brass color. Доступен под заказ также в цвете старого золота.
- \* W sprzedaży z eurowkrętami (ZE) lub bez (BE) \* Available on sale with (ZE) or without (BE) Euro screws \* В продаже имеются с евро (ZE) и без евро шурупа (BE)
- Dostępne wysokości prowadnika H=2 Available slider heights H=2 Высота ответной планки H=2

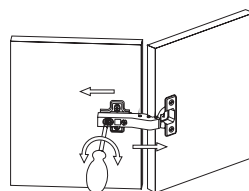

Regulacja pozioma  
Horizontal adjustment  
Регулировка по горизонтали

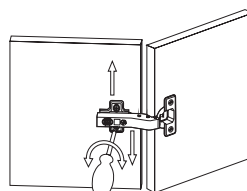

Regulacja pionowa  
Vertical adjustment  
Регулировка по вертикали

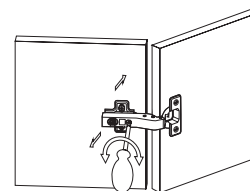

Regulacja głębokości  
Depth adjustment  
Регулировка глубины



stal / steel / сталь

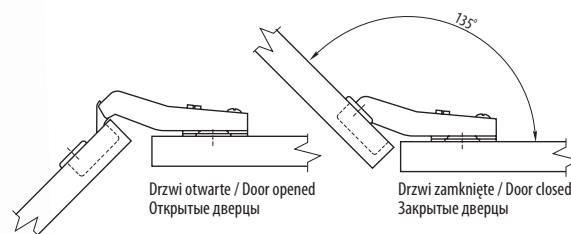

Drzwi otwarte / Door opened  
Открытые дверцы

Drzwi zamknięte / Door closed  
Закрытые дверцы

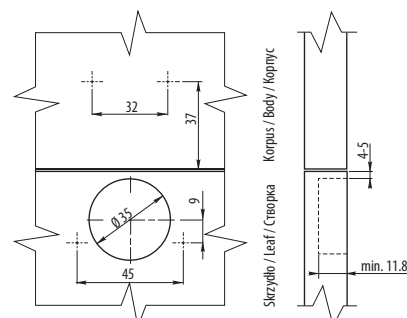

Wymiary montażowe / Mounting dimensions / Монтажные размеры

## Zawias GTV kątowy 90°

GTV hinge, angular 90° / Угловая петля GTV 90°

Index: ZP-KT90H2-..  
(\*)

### Cechy produktu / Features / Характеристика товара:

- Dostępny na zamówienie także w kolorze stare złoto. Also available in antique brass color. Доступен под заказ также в цвете старого золота.
- \* W sprzedaży z eurowkrętami (ZE) lub bez (BE) \* Available on sale with (ZE) or without (BE) Euro screws \* В продаже имеются с евро шурупа (BE)
- Dostępne wysokości prowadnika H=2 Available slider heights H=2 Высота ответной планки H=2

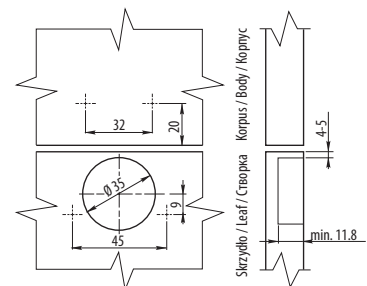
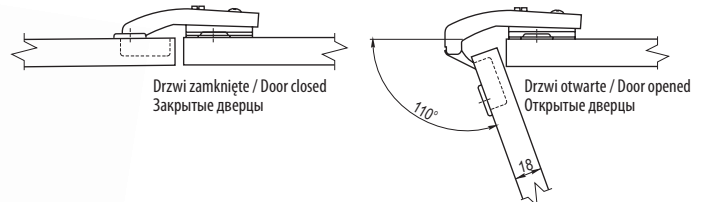
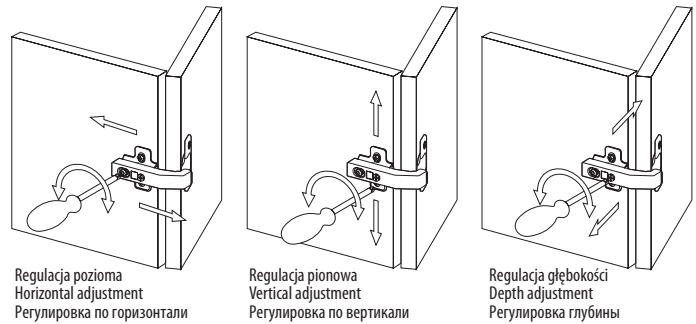

stal / steel / сталь

material

## Zawias GTV kątowy 135°

GTV hinge, angular 135° / Угловая петля GTV 135°

Index: ZP-KT135H2-..  
(\*)

### Cechy produktu / Features / Характеристика товара:

- \* W sprzedaży z eurowkrętami (ZE) lub bez (BE) \* Available on sale with (ZE) or without (BE) Euro screws \* В продаже имеются с евро шурупа (BE)
- Dostępne wysokości prowadnika H=2 Available slider heights H=2 Высота ответной планки H=2

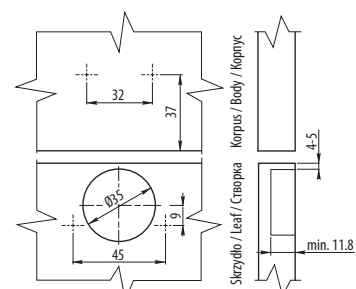
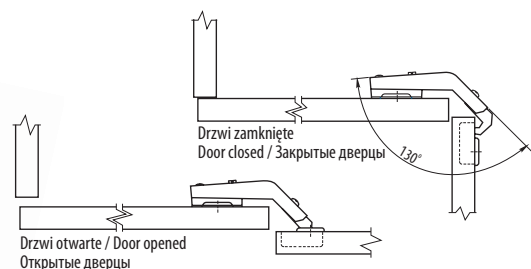
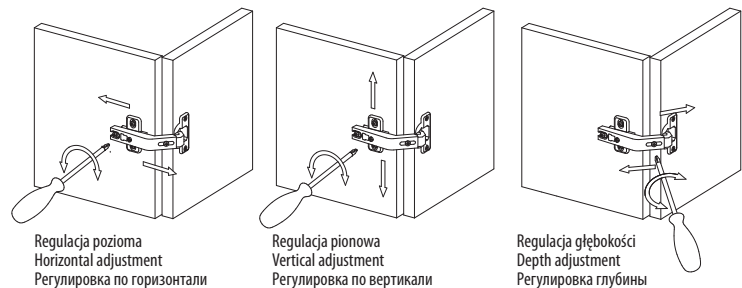

stal / steel / сталь

material

## Zawias GTV kątowy 165°

GTV hinge, angular 165° / Угловая петля GTV 165°

Index: ZP-KT165H2..  
(\*)

### Cechy produktu / Features / Характеристика товара:

- \* W sprzedaży z eurowkrętami (ZE) lub bez (BE)
- \* Available on sale with (ZE) or without (BE) Euro screws
- \* В продаже имеются с евро (ZE) и без евро шурупа (BE)
- Dostępne wysokości prowadnika H=2
- Available slider heights H=2
- Высота ответной планки H=2

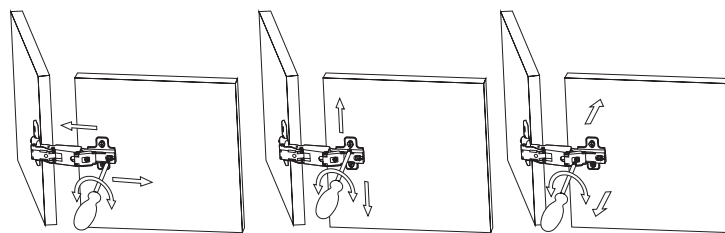

Regulacja pozioma  
Horizontal adjustment  
Регулировка по горизонтали

Regulacja pionowa  
Vertical adjustment  
Регулировка по вертикали

Regulacja głębokości  
Depth adjustment  
Регулировка глубины



stal / steel / сталь

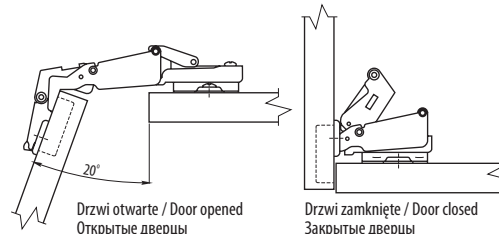

Drzwi otwarte / Door opened  
Открытые двери

Drzwi zamknięte / Door closed  
Закрытые двери

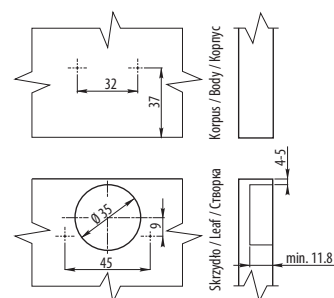

Wymiary montażowe / Mounting dimensions / Монтажные размеры

## Zawias GTV clip-on. Drzwi nakładane

GTV hinge, clip-on. Lift-off door / Петля GTV с клипом. Наружные двери

Index: ZP-CONL09-..  
(\*)

### Cechy produktu / Features / Характеристика товара:

- \* W sprzedaży z eurowkrętami (ZE) lub bez (BE)
- \* Available on sale with (ZE) or without (BE) Euro screws
- \* В продаже имеются с евро (ZE) и без евро шурупа (BE)
- Dostępne wysokości prowadnika H=2
- Available slider heights H=2
- Высота ответной планки H=2

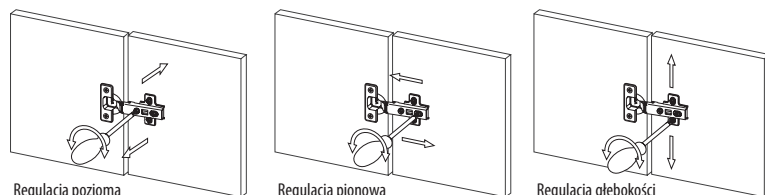

Regulacja pozioma  
Horizontal adjustment  
Регулировка по горизонтали

Regulacja pionowa  
Vertical adjustment  
Регулировка по вертикали

Regulacja głębokości  
Depth adjustment  
Регулировка глубины

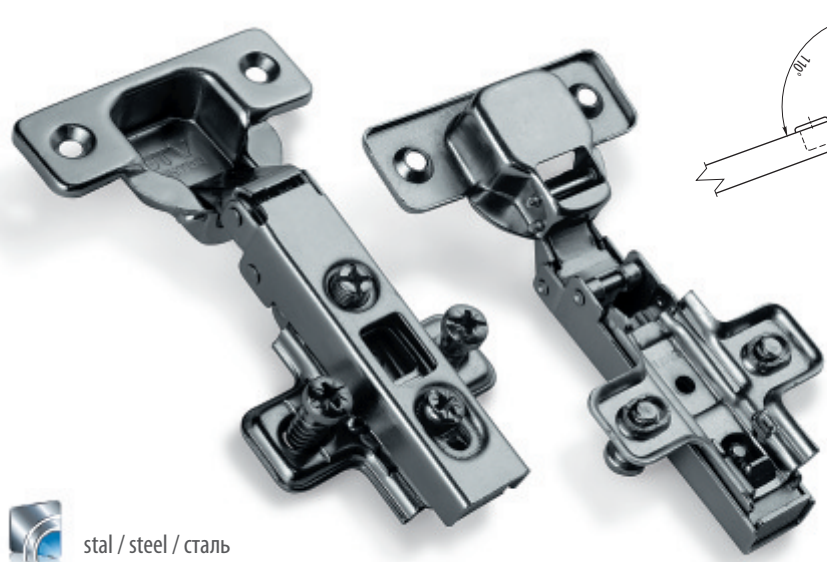

stal / steel / сталь

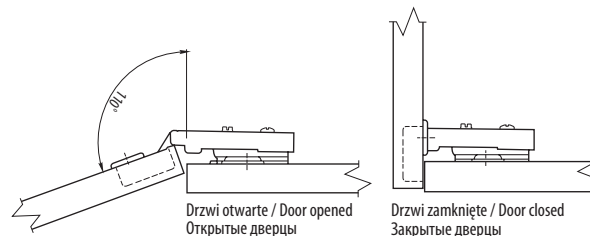

Drzwi otwarte / Door opened  
Открытые двери

Drzwi zamknięte / Door closed  
Закрытые двери

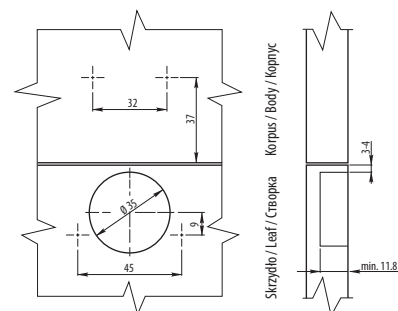

Wymiary montażowe / Mounting dimensions / Монтажные размеры

## Zawias GTV clip-on. Drzwi bliźniacze

Index: ZP-CONL08--  
(\*)

GTV hinge, clip-on. Twin door / Петля GTV с клипом. Двойные двери

### Cechy produktu / Features / Характеристика товара:

- \* W sprzedaży z eurowkrętami (ZE) lub bez (BE)
- \* Available on sale with (ZE) or without (BE) Euro screws
- \* В продаже имеются с евро (ZE) и без евро шурупа (BE)
- Dostępne wysokości prowadnika H=2
- Available slider heights H=2
- Высота ответной планки H=2

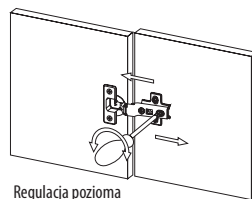

Regulacja pozioma  
Horizontal adjustment  
Регулировка по горизонтали

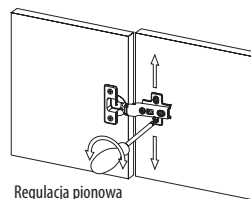

Regulacja pionowa  
Vertical adjustment  
Регулировка по вертикали

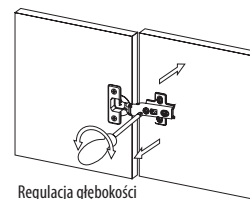

Regulacja głębokości  
Depth adjustment  
Регулировка глубины



stal / steel / сталь

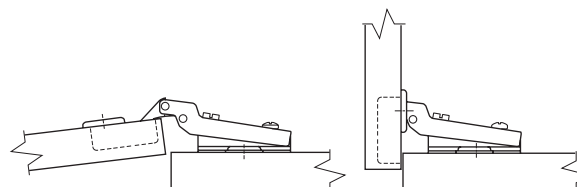

Drzwi otwarte / Door opened  
Открытые двери

Drzwi zamknięte / Door closed  
Закрытые двери

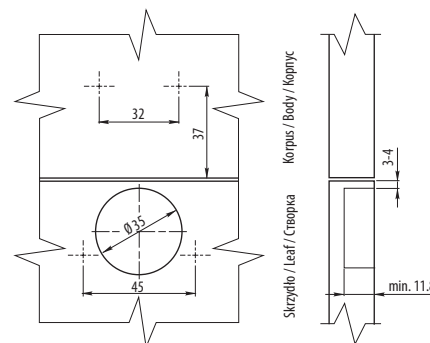

Wymiary montażowe / Mounting dimensions / Монтажные размеры

## Zawias GTV clip-on. Drzwi wpuszczane

Index: ZP-CONL07--  
(\*)

GTV hinge, clip-on. Flush door / Петля GTV с клипом. Внутренние двери

### Cechy produktu / Features / Характеристика товара:

- \* W sprzedaży z eurowkrętami (ZE) lub bez (BE)
- \* Available on sale with (ZE) or without (BE) Euro screws
- \* В продаже имеются с евро (ZE) и без евро шурупа (BE)
- Dostępne wysokości prowadnika H=2
- Available slider heights H=2
- Высота ответной планки H=2

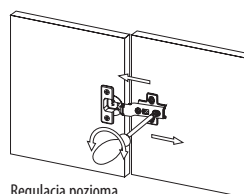

Regulacja pozioma  
Horizontal adjustment  
Регулировка по горизонтали

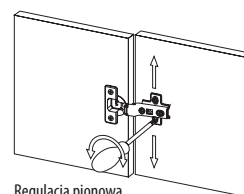

Regulacja pionowa  
Vertical adjustment  
Регулировка по вертикали

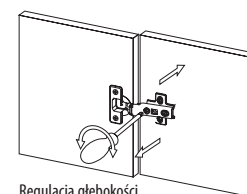

Regulacja głębokości  
Depth adjustment  
Регулировка глубины



stal / steel / сталь

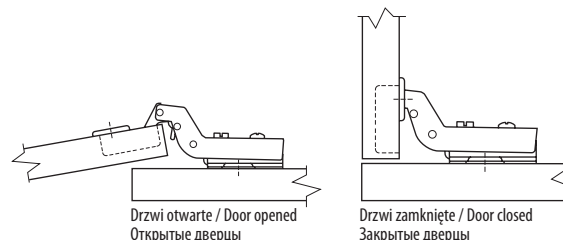

Drzwi otwarte / Door opened  
Открытые двери

Drzwi zamknięte / Door closed  
Закрытые двери

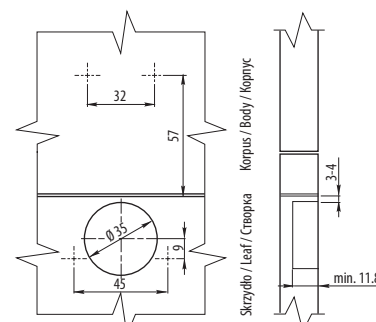

Wymiary montażowe / Mounting dimensions / Монтажные размеры

## Zawias GTV hydrauliczny, clip-on. Drzwi nakładane

Index: ZM-CNHC09-..\*\*\*, ZM-ECHC09..0  
(\*) (\*)

GTV hinge, hydraulic, clip-on. Lift-off door / Петля GTV гидравлическая, с клипом. Наружные дверцы

### Cechy produktu / Features / Характеристика товара:

- Wkręty do drewna w zestawie  
Wood screws included  
В комплекте – шурупы для деревянных изделий
- \*\* Wersja PRESTIGE z ekskluzywną zaślepką w zestawie  
\*\* Prestige version with exclusive plug included  
\*\* Вeрсия Prestige – с эксклюзивной заглушкой в комплекте
- \* W sprzedaży z eurowkrętami (ZE) lub bez (BE)  
\* Available on sale with (ZE) or without (BE) Euro screws  
\* В продаже имеются с евро (ZE) и без евро шурупа (BE)
- Dostępne wysokości prowadnika H=0, H=2  
Available slider heights H=0, H=2  
Высота ответной планки H=0, H=2

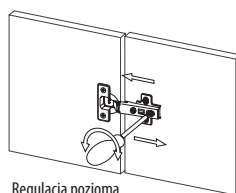

Regulacja pozioma  
Horizontal adjustment  
Регулировка по горизонтали

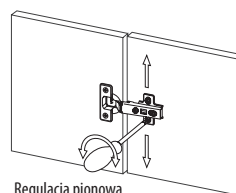

Regulacja pionowa  
Vertical adjustment  
Регулировка по вертикали

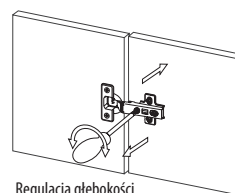

Regulacja głębokości  
Depth adjustment  
Регулировка глубины

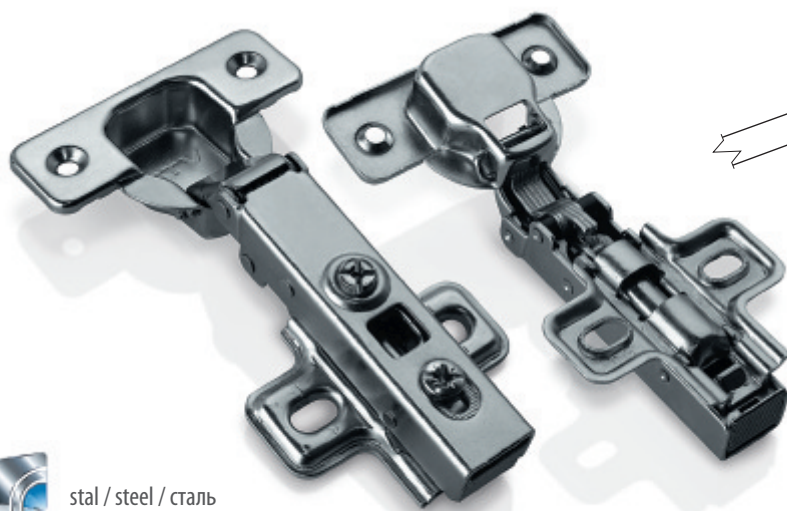

stal / steel / сталь

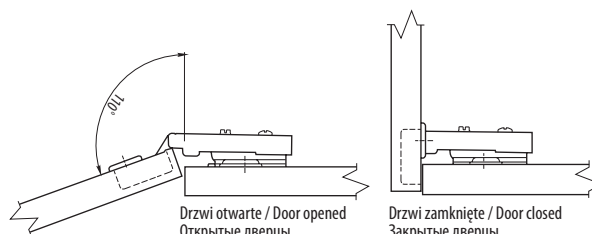

Drzwi otwarte / Door opened  
Открытые дверцы

Drzwi zamknięte / Door closed  
Закрытые дверцы

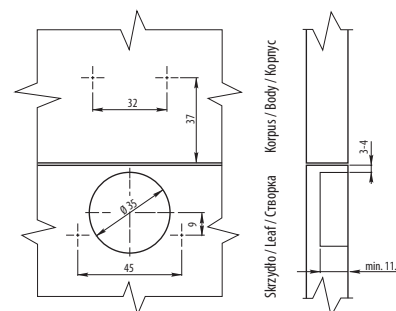

Wymiary montażowe / Mounting dimensions / Монтажные размеры

## Zawias GTV hydrauliczny, clip-on. Drzwi bliźniacze

Index: ZM-CNHC08-..\*\*\*, ZM-ECHC08..0  
(\*) (\*)

GTV hinge, hydraulic, clip-on. Twin door / Петля GTV гидравлическая, с клипом. Двойные дверцы

### Cechy produktu / Features / Характеристика товара:

- Wkręty do drewna w zestawie  
Wood screws included  
В комплекте – шурупы для деревянных изделий
- \*\* Wersja PRESTIGE z ekskluzywną zaślepką w zestawie  
\*\* Prestige version with exclusive plug included  
\*\* Вeрсия Prestige – с эксклюзивной заглушкой в комплекте
- \* W sprzedaży z eurowkrętami (ZE) lub bez (BE)  
\* Available on sale with (ZE) or without (BE) Euro screws  
\* В продаже имеются с евро (ZE) и без евро шурупа (BE)
- Dostępne wysokości prowadnika H=0, H=2  
Available slider heights H=0, H=2  
Высота ответной планки H=0, H=2

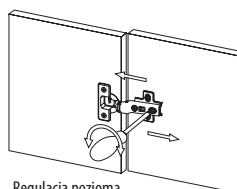

Regulacja pozioma  
Horizontal adjustment  
Регулировка по горизонтали

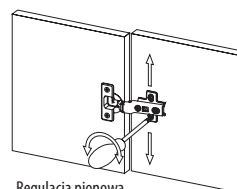

Regulacja pionowa  
Vertical adjustment  
Регулировка по вертикали

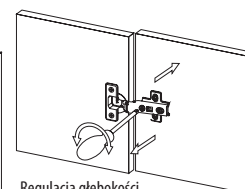

Regulacja głębokości  
Depth adjustment  
Регулировка глубины



stal / steel / сталь

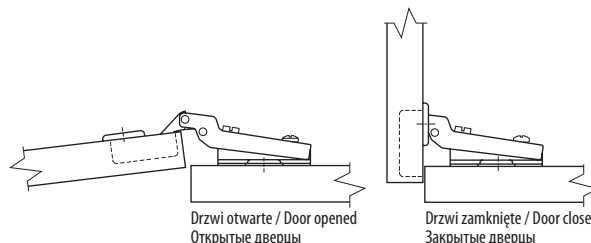

Drzwi otwarte / Door opened  
Открытые дверцы

Drzwi zamknięte / Door closed  
Закрытые дверцы

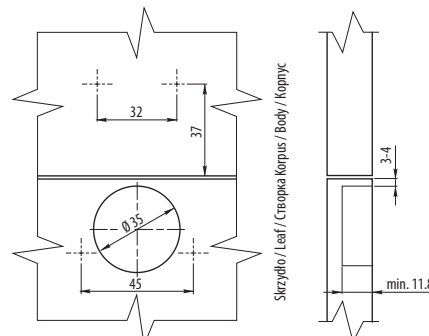

Wymiary montażowe / Mounting dimensions / Монтажные размеры

## Zawias GTV hydrauliczny, clip-on. Drzwi wpuszczane

Index: ZM-CNHC07-..\*\*, ZM-ECHC07..0  
(\*)

GTV hinge, hydraulic, clip-on. Flush door / Петля GTV гидравлическая, с клипом. Внутренние дверцы

### Cechy produktu / Features / Характеристика товара:

- Wkręty do drewna w zestawie  
Wood screws included  
В комплекте – шурупы для деревянных изделий
- \*\* Wersja PRESTIGE z ekskluzywną zasławką w zestawie  
\*\* Prestige version with exclusive plug included  
\*\* Версия Prestige – с эксклюзивной заглушкой в комплекте
- \* W sprzedaży z eurowkrętami (ZE) lub bez (BE)  
\* Available on sale with (ZE) or without (BE) Euro screws  
\* В продаже имеются с евро (ZE) и без евро шурупа (BE)
- Dostępne wysokości prowadnika H=0, H=2  
Available slider heights H=0, H=2  
Высота ответной планки H=0, H=2

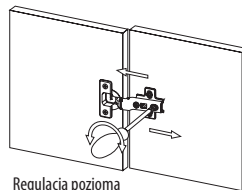

Regulacja pozioma  
Horizontal adjustment  
Регулировка по горизонтали

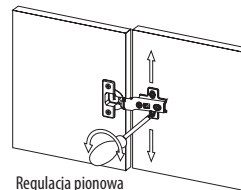

Regulacja pionowa  
Vertical adjustment  
Регулировка по вертикали

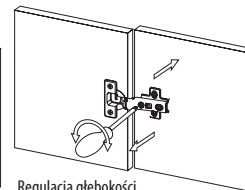

Regulacja głębokości  
Depth adjustment  
Регулировка глубины

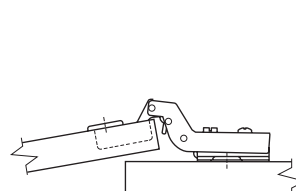

Drzwi otwarte / Door opened  
Открытые дверцы

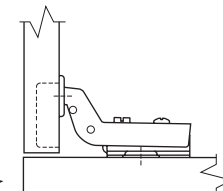

Drzwi zamknięte / Door closed  
Закрытые дверцы

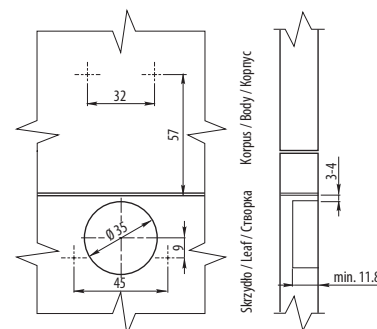

stal / steel / сталь

material

## Zawias GTV mini, hydrauliczny. Drzwi nakładane

Index: ZP-C1HC090ZE

GTV hinge, mini, hydraulic. Lift-off door / Петля GTV мини, гидравлическая. Наружные дверцы

### Cechy produktu / Features / Характеристика товара:

- W sprzedaży z eurowkrętami  
Available on sale with Euro screws  
В продаже имеются с евро шурупа
- Dostępne wysokości prowadnika H=0  
Available slider heights H=0  
Высота ответной планки H=0

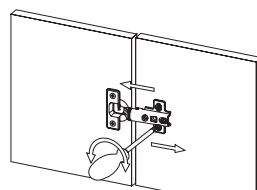

Regulacja pozioma  
Horizontal adjustment  
Регулировка по горизонтали

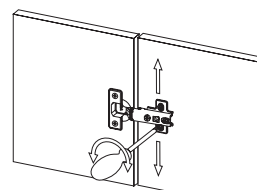

Regulacja pionowa  
Vertical adjustment  
Регулировка по вертикали

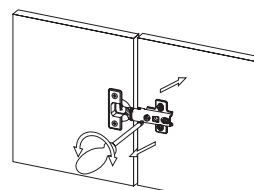

Regulacja głębokości  
Depth adjustment  
Регулировка глубины

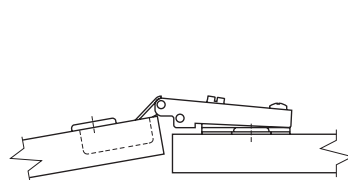

Drzwi otwarte / Door opened  
Открытые дверцы

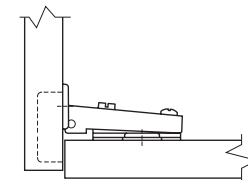

Drzwi zamknięte / Door closed  
Закрытые дверцы

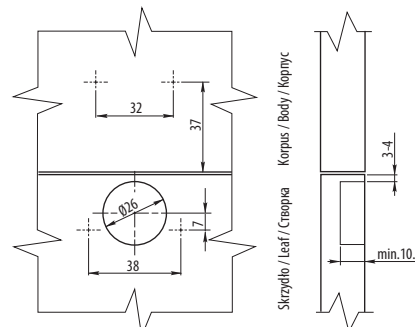

stal / steel / сталь

material

## Zawias GTV kątowy 30°, hydrauliczny, clip-on

Index: ZM-HCKT30-BE

GTV hinge, angular 30°, hydraulic, clip-on / Угловая петля GTV 30°, гидравлическая, с клипом

### Cechy produktu / Features / Характеристика товара:

- W sprzedaży bez eurowkrętów  
On sale without Euro screws  
В продаже без евро шурупа
- Dostępne wysokości prowadnika H=0  
Available slider heights H=0  
Высота ответной планки H=0

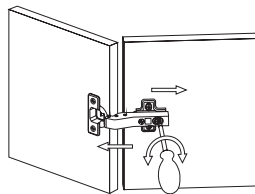

Regulacja pozioma  
Horizontal adjustment  
Регулировка по горизонтали

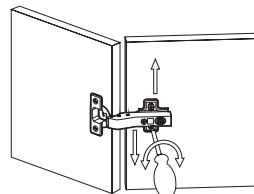

Regulacja pionowa  
Vertical adjustment  
Регулировка по вертикали

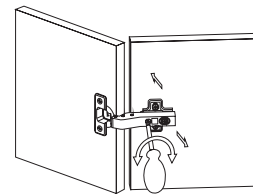

Regulacja głębokości  
Depth adjustment  
Регулировка глубины



ZnAl + stal  
ZnAl + steel / ZnAl + сталь

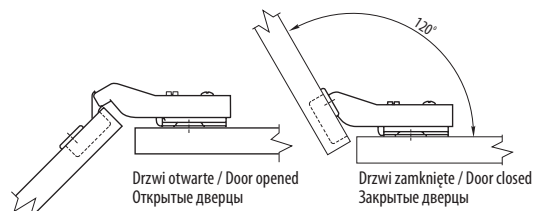

Drzwi otwarte / Door opened  
Открытые двери

Drzwi zamknięte / Door closed  
Закрытые двери

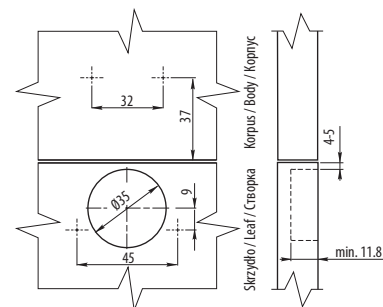

Wymiary montażowe / Mounting dimensions / Монтажные размеры

## Zawias GTV kątowy 45°, hydrauliczny, clip-on

Index: ZM-HCKT45-BE

GTV hinge, angular 45°, hydraulic, clip-on / Угловая петля GTV 45°, гидравлическая, с клипом

### Cechy produktu / Features / Характеристика товара:

- W sprzedaży bez eurowkrętów  
On sale without Euro screws  
В продаже без евро шурупа
- Dostępne wysokości prowadnika H=0  
Available slider heights H=0  
Высота ответной планки H=0

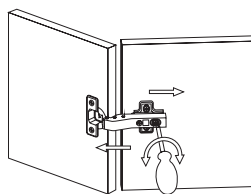

Regulacja pozioma  
Horizontal adjustment  
Регулировка по горизонтали

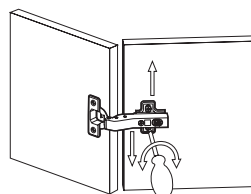

Regulacja pionowa  
Vertical adjustment  
Регулировка по вертикали

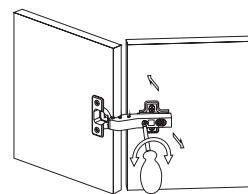

Regulacja głębokości  
Depth adjustment  
Регулировка глубины



ZnAl + stal  
ZnAl + steel / ZnAl + сталь

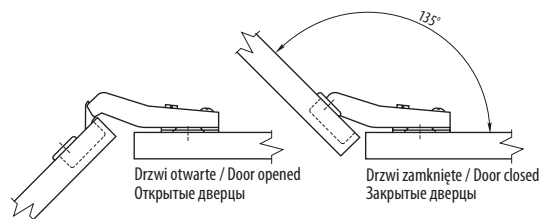

Drzwi otwarte / Door opened  
Открытые двери

Drzwi zamknięte / Door closed  
Закрытые двери

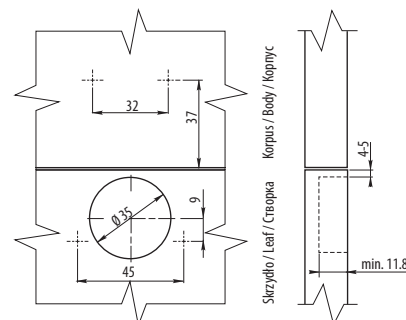

Wymiary montażowe / Mounting dimensions / Монтажные размеры

## Zawias GTV kątowy 90°, hydrauliczny, clip-on

Index: ZM-HCKT90-BE

GTV hinge, angular 90°, hydraulic, clip-on / Угловая петля GTV 90°, гидравлическая, с клипом

### Cechy produktu / Features / Характеристика товара:

- W sprzedaży bez eurokrętwów  
On sale without Euro screws
- В продаже без евро шурупов
- Dostępne wysokości prowadnika H=0  
Available slider heights H=0
- Высота ответной планки H=0

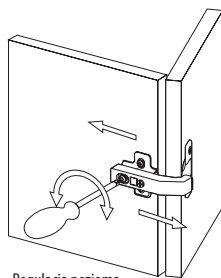

Regulacja pozioma  
Horizontal adjustment  
Регулировка по горизонтали

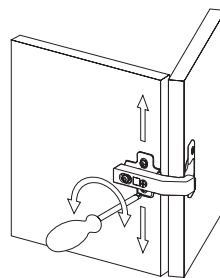

Regulacja pionowa  
Vertical adjustment  
Регулировка по вертикали

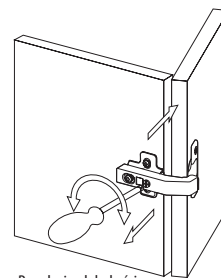

Regulacja głębokości  
Depth adjustment  
Регулировка глубины



ZnAl + stal  
ZnAl + steel / ZnAl + сталь

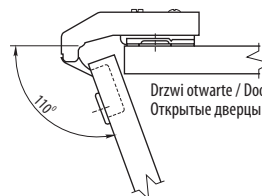

Drzwi otwarte / Door opened  
Открытые двери



Drzwi zamknięte / Door closed  
Закрытые двери

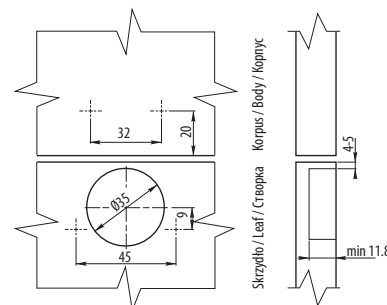

Wymiary montażowe / Mounting dimensions / Монтажные размеры

## Zawias „Junior” 75°

Index: ZP-JUNIOR-00

„Junior” hinge 75° / Петля „Junior” 75°



stal / steel / сталь

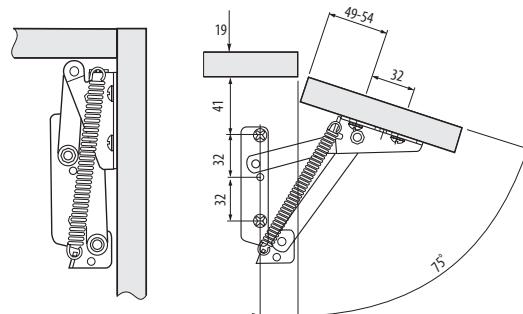

## Zawias GTV do szkła. Drzwi nakładane

Index: ZP-CIG-09...  
(\*) (\*\*)

GTV hinge for glass. Lift-off door / Петля GTV для стеклянных дверей. Наружные дверцы

### Cechy produktu / Features / Характеристика товара:

- \* W zestawie zaślepka owalna (U) lub okrągła (O)  
\* Oval (U) or round (O) plug included  
\* В комплекте овальная или круглая заглушка
- Zaślepki dostępne w dwóch kolorach:  
Plugs available in two colours:  
Заглушки доступны в двух цветах: 
- \*\* Dostępny w sprzedaży z eurowkrętami (ZE) lub bez (BE)  
\*\* Available on sale with (ZE) or without (BE) Euro screws  
\*\* В продаже имеются с евро (ZE) и без евро шурупа (BE)
- Dostępne wysokości prowadnika H=0  
Available slider heights H=0  
Высота ответной планки H=0

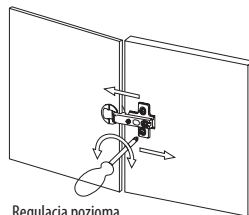

Regulacja pozioma  
Horizontal adjustment  
Регулировка по горизонтали

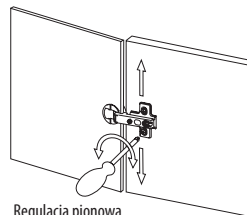

Regulacja pionowa  
Vertical adjustment  
Регулировка по вертикали

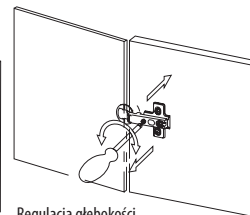

Regulacja głębokości  
Depth adjustment  
Регулировка глубины



stal + plastik / steel + plastic  
сталь + пластмасса

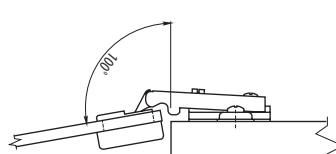

Drzwi otwarte / Door opened  
Открытые дверцы

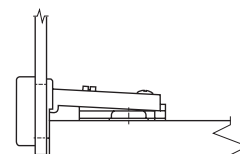

Drzwi zamknięte / Door closed  
Закрытые дверцы

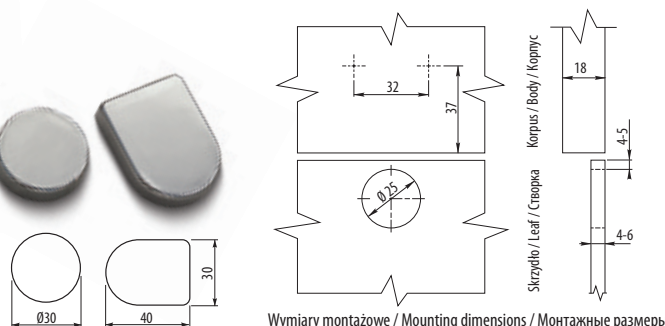

## Zawias GTV do szkła. Drzwi wpuszczane

Index: ZP-CIG-07...  
(\*) (\*\*)

GTV hinge for glass. Flush door / Петля GTV для стеклянных дверей. Внутренние дверцы

### Cechy produktu / Features / Характеристика товара:

- \* W zestawie zaślepka owalna (U) lub okrągła (O)  
\* Oval (U) or round (O) plug included  
\* В комплекте овальная или круглая заглушка
- Zaślepki dostępne w dwóch kolorach:  
Plugs available in two colours:  
Заглушки доступны в двух цветах: 
- \*\* Dostępny w sprzedaży z eurowkrętami (ZE) lub bez (BE)  
\*\* Available on sale with (ZE) or without (BE) Euro screws  
\*\* В продаже имеются с евро (ZE) и без евро шурупа (BE)
- Dostępne wysokości prowadnika H=0  
Available slider heights H=0  
Высота ответной планки H=0

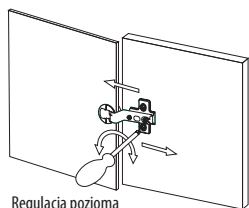

Regulacja pozioma  
Horizontal adjustment  
Регулировка по горизонтали

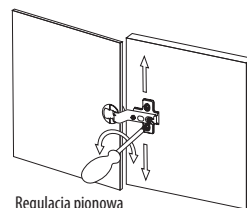

Regulacja pionowa  
Vertical adjustment  
Регулировка по вертикали

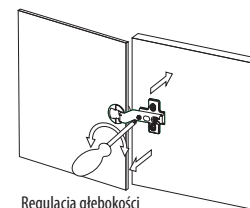

Regulacja głębokości  
Depth adjustment  
Регулировка глубины



stal + plastik / steel + plastic  
сталь + пластмасса

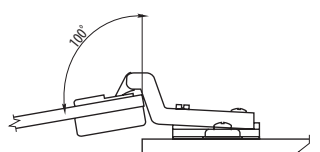

Drzwi otwarte / Door opened  
Открытые дверцы

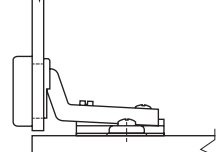

Drzwi zamknięte / Door closed  
Закрытые дверцы

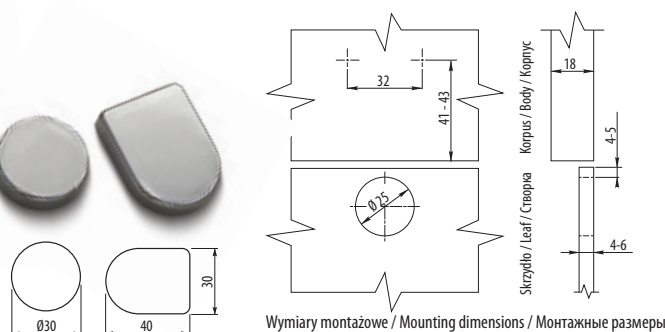

## Zawias GTV do ramek aluminiowych, clip-on. Drzwi nakładane

Index: ZP-RALUH2-00

GTV hinge for aluminium frame, clip-on. Lift-off door / Петля GTV для алюминиевых рамок, с клипом. Наружные двери

### Cechy produktu / Features / Характеристика товара:

- Dostępne wysokości prowadnika H=2  
Available slider heights H=2  
Высота ответной планки H=2

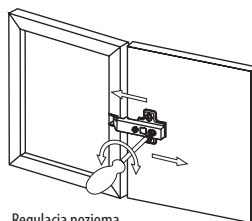

Regulacja pozioma  
Horizontal adjustment  
Регулировка по горизонтали

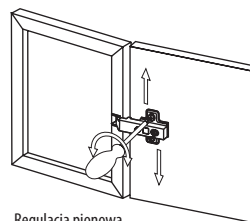

Regulacja pionowa  
Vertical adjustment  
Регулировка по вертикали

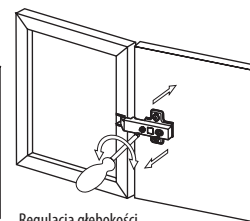

Regulacja głębokości  
Depth adjustment  
Регулировка глубины

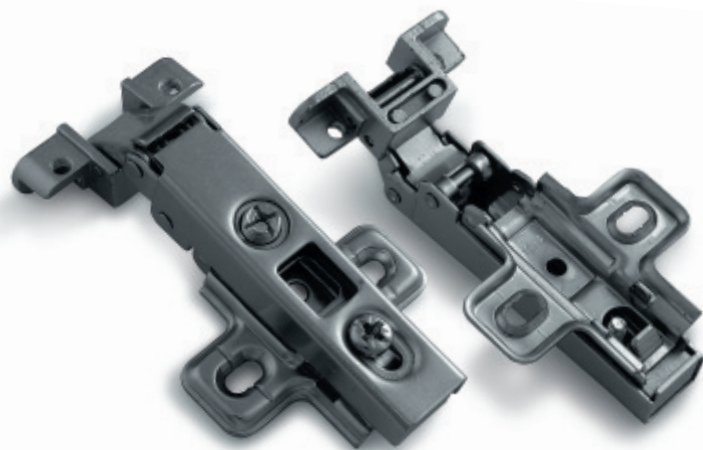

stal / steel / сталь

material

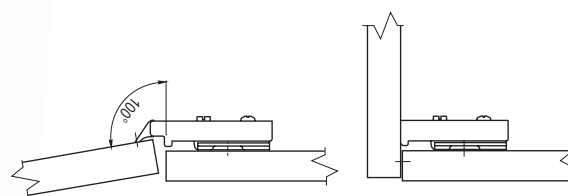

Drzwi otwarte / Door opened  
Открытые двери

Drzwi zamknięte / Door closed  
Закрытые двери

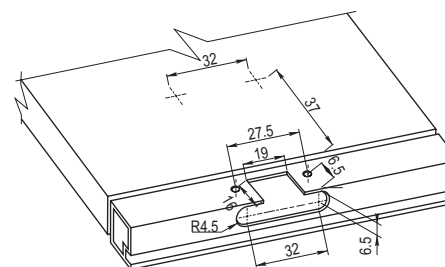

Wymiary montażowe / Mounting dimensions / Монтажные размеры

## Zawias GTV do ramek aluminiowych, hydrauliczny, clip-on. Drzwi nakładane

GTV hinge for aluminium frame, hydraulic, clip-on. Lift-off door / Петля GTV для алюминиевых рамок, гидравлическая, с клипом. Наружные двери

Index: ZM-HCRALU9BE

### Cechy produktu / Features / Характеристика товара:

- W sprzedaży bez eurowkrętów  
On sale without Euro screws  
В продаже без евро шурупа
- Dostępne wysokości prowadnika H=0  
Available slider heights H=0  
Высота ответной планки H=0

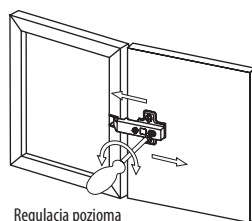

Regulacja pozioma  
Horizontal adjustment  
Регулировка по горизонтали

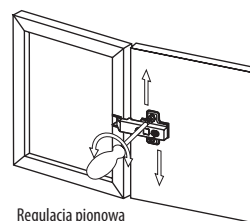

Regulacja pionowa  
Vertical adjustment  
Регулировка по вертикали

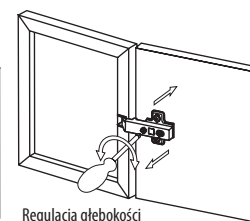

Regulacja głębokości  
Depth adjustment  
Регулировка глубины

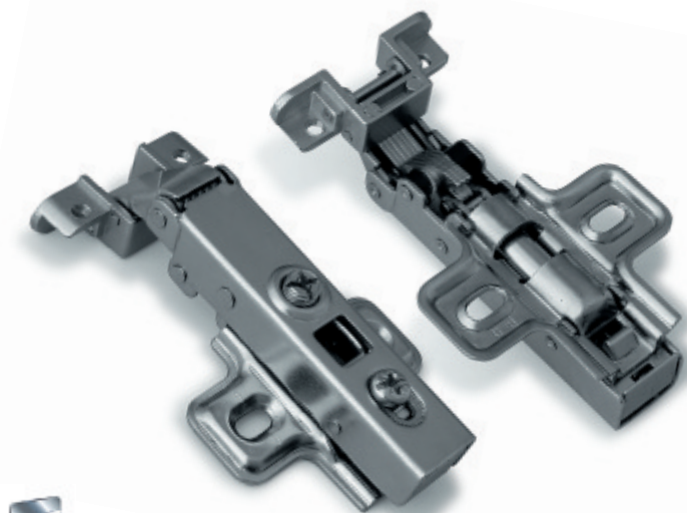

stal / steel / сталь

material

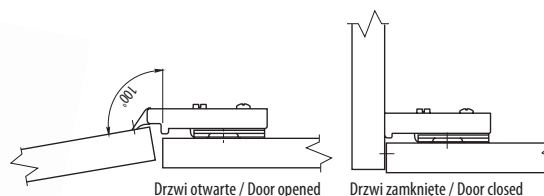

Drzwi otwarte / Door opened  
Открытые двери

Drzwi zamknięte / Door closed  
Закрытые двери

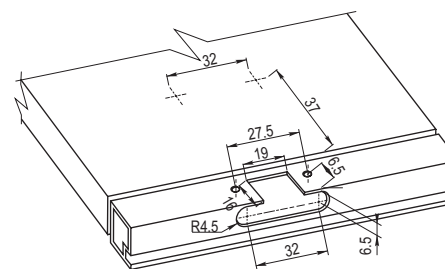

Wymiary montażowe / Mounting dimensions / Монтажные размеры

## Zawias GTV tłoczkowy mały

Index: ZT-HF-01-M00

GTV hinge, piston-type, small / Поршневая петля GTV малая

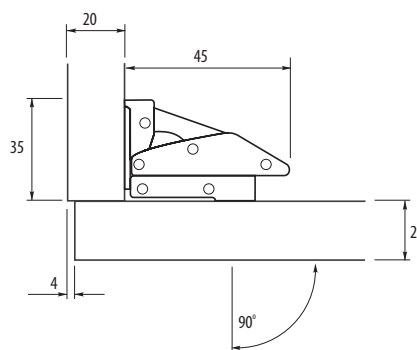

stal / steel / сталь

material

## Zawias GTV tłoczkowy duży

Index: ZT-HF-01-D00

GTV hinge, piston-type, big / Поршневая петля GTV большая

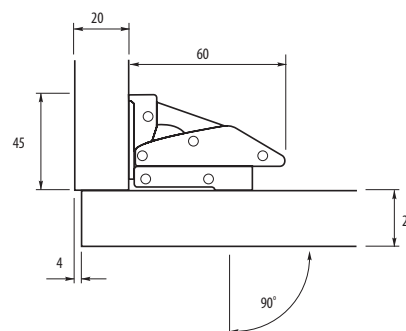

stal / steel / сталь

material

## Zawias cylindryczny

Index: ZC-GTV-12-00, ZC-GTV-14-00

Cylinder hinge / Петля цилиндрическая

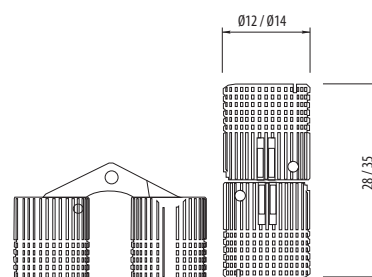

mosiądz / brass / латунь

material



color



28 mm / Ø12, 35 mm / Ø14

size

## Prowadnik bez eurowkrętów

Hinge plate without euro-screws / Ответная планка

Index: PZ-BI-...-BEO  
(H)

### Cechy produktu / Features / Характеристика товара:

- dostępne wysokości H=0, H=2, H=4  
Available heights H=0, H=2, H=4  
доступные размеры по высоте H=0, H=2, H=4

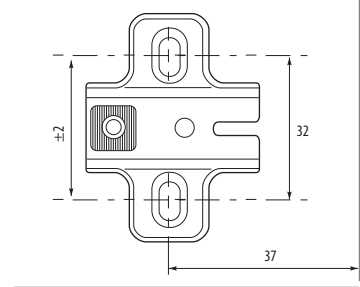
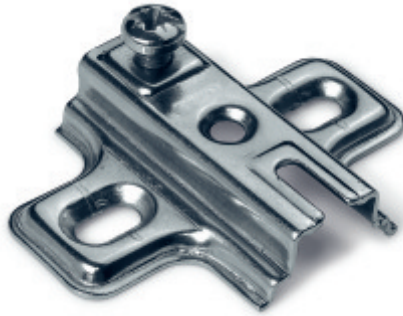

stal / steel / сталь

material

## Prowadnik z eurowkrętami

Hinge plate with euro-screws / Ответная планка с евровинтом

Index: PZ-BI-...-ZEO  
(H)

### Cechy produktu / Features / Характеристика товара:

- dostępne wysokości H=0, H=2, H=4  
Available heights H=0, H=2, H=4  
доступные размеры по высоте H=0, H=2, H=4

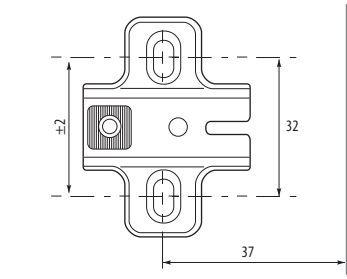
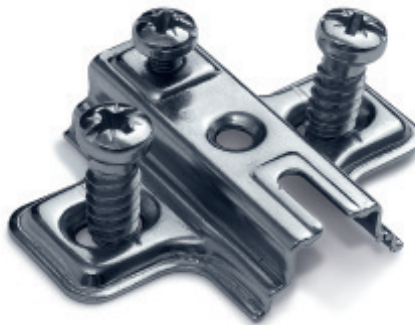

stal / steel / сталь

material

## Amortyzator

Buffer / Амортизатор

Index: AM-KRZYZ-KPL\*, AM-PROST-KPL\*\*

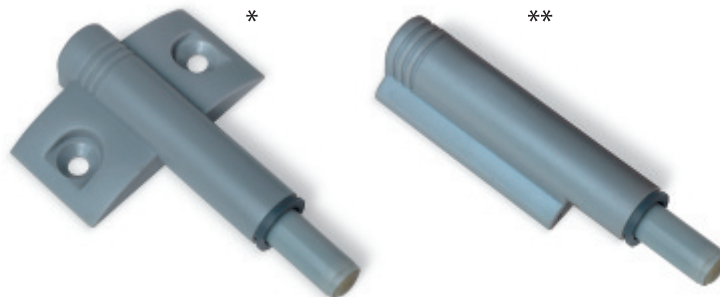

plastik / plastic / пластмасса

material



color

## Amortyzator PRESTIGE

Buffer PRESTIGE / Амортизатор PRESTIGE

Index: AM-ODB000-60\*, AM-ADAP0A-60\*\*, AM-ADAP0B-60\*\*\*  
 amortyzator / buffer / амортизатор      adapter / адаптер      adapter / адаптер

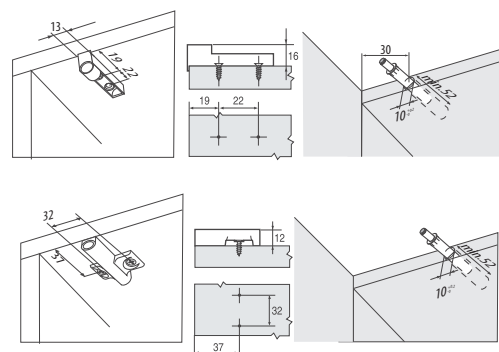

plastik / plastic / пластмасса



## Odbojnik magnetyczny

Magnetic door stop / Толкатель с магнитным окончанием

Index: AM-PL-DL-MAG

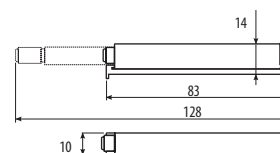

plastik / plastic / пластмасса



## Odbojnik z końcówką kauczukową

Door stop with rubber end / Толкатель с каучуковым окончанием

Index: AM-PLA-DLU-0

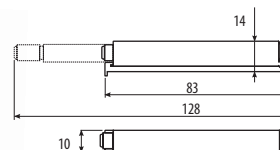

plastik / plastic / пластмасса



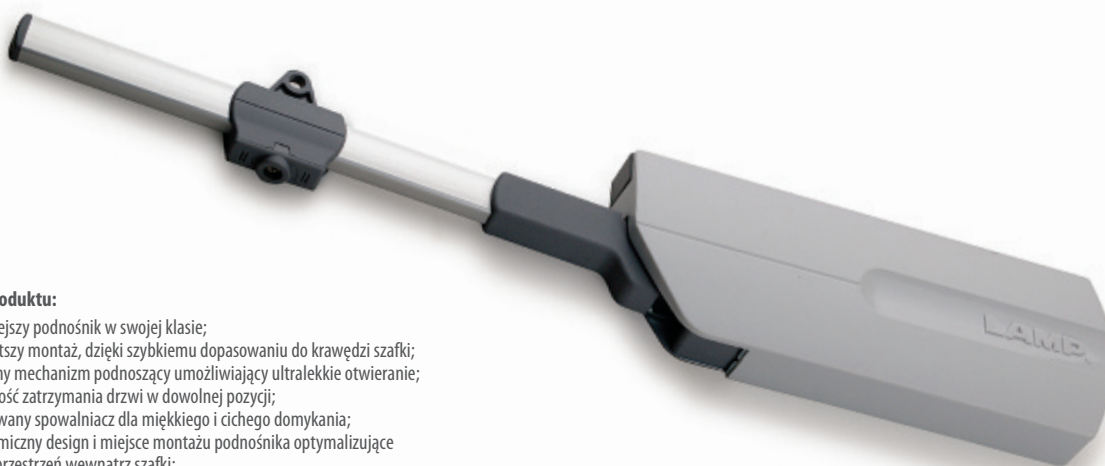

### Cechy produktu:

- najsilniejszy podnośnik w swojej klasie;
- najprostszy montaż, dzięki szybkiemu dopasowaniu do krawędzi szafka;
- specjalny mechanizm podnoszący umożliwiający ultralekkie otwieranie;
- możliwość zatrzymania drzwi w dowolnej pozycji;
- wbudowany spowalniacz dla miękkiego i cichego domykania;
- ergonomiczny design i miejsce montażu podnośnika optymalizujące wolną przestrzeń wewnątrz szafka;
- gwarantowane bezawaryjne 40 000 cykli;
- dwa rodzaje podnośnika:
  - z silownikiem standardowym do klap lekkich (typ M)
  - i silownikiem silnym do klap ciężkich i wysokich (typ H).

### Features:

- Lapcon stay for upward-opening flap doors
- Lift-assist mechanism for extra light-opening
- Door stays in any desired position
- Damper equipped for soft & silent closing at the end
- Slim design and installed location maximizes space inside of cabinet
- Simple installation by aligning body to edge of cabinet
- Single or pair use allows wide range of door size / weight
- Recognized by LGA for 40,000 cycles
- Optional bracket for aluminum frame door coming soon

\* Mocowanie do ramki aluminiowej 20 mm

\* Attaching to aluminium frame 20 mm / \* Крепление к алюминиевой рамке 20 мм



### Характеристика товара:

- Самый мощный подъемник в своем классе
- Самый лёгкий монтаж, благодаря быстрому приспособлению к краю шкафчика
- Специальный механизм, позволяющий на ультралёгкое открывание
- Возможность приостановления двери в любой позиции
- Встроенный замедлитель для мягкого и тихого самодоката
- Эргономический дизайн, а также место монтажа подъемника, оптимизирующие свободное пространство внутри шкафчика
- Гарантированных безаварийных 40 000 циклей
- Два типа подъёмника:
  - со стандартным сервомотором для лёгкого клапана (тип М)
  - с мощным сервомотором для клапанов тяжёлых и высоких (тип Н)

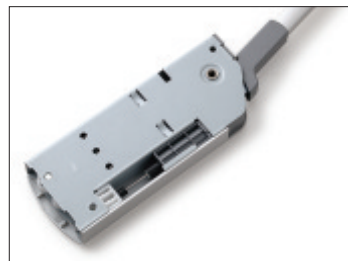

### Trzy zalety / 3 functions on 1 stay / Три достоинства

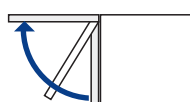

1. Wspomaganie ultralekkiego otwierania  
Lift-assist / Поддержка ультралёгкого открывания

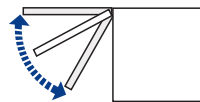

2. Zatrzymanie drzwi w dowolnym miejscu  
Free stop / Приостановление двери в любом положении

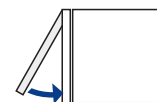

3. Delikatne i ciche domykanie  
Soft-close / Деликатный и тихий докат



aluminum / stal / ABS  
aluminum / steel / ABS  
алюминий / сталь / ABS



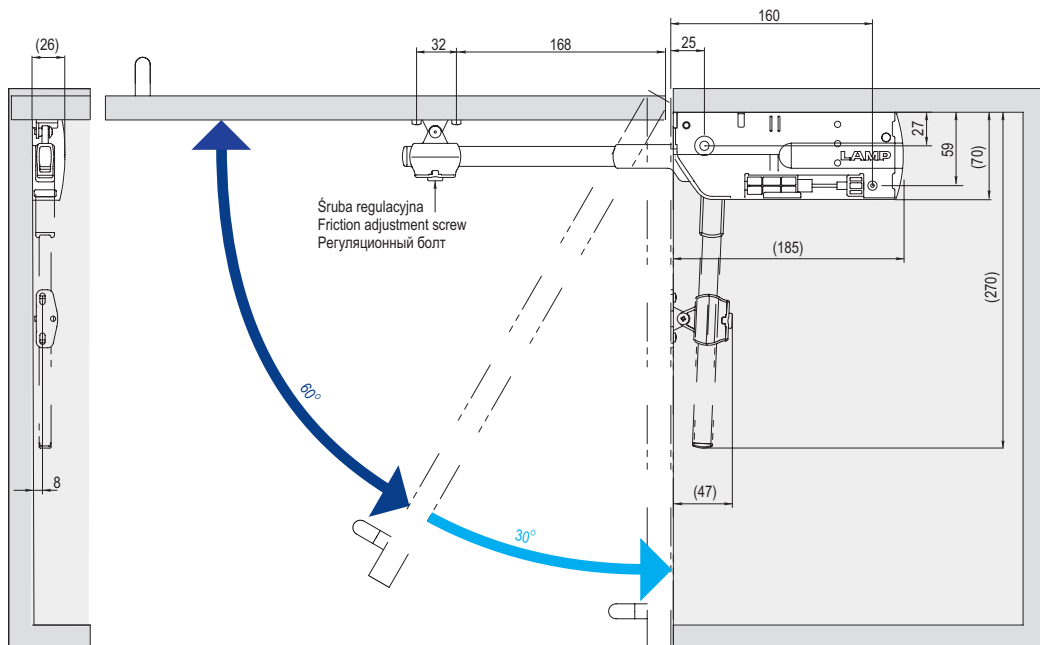

- █ Zatrzymanie kłapy w dowolnym miejscu / Free stop  
Приостановление клапана в любом положении
- █ Miękki domyk / Soft-close / Мягкий докат

Sposób montażu / Easy Installation / Способ монтажа

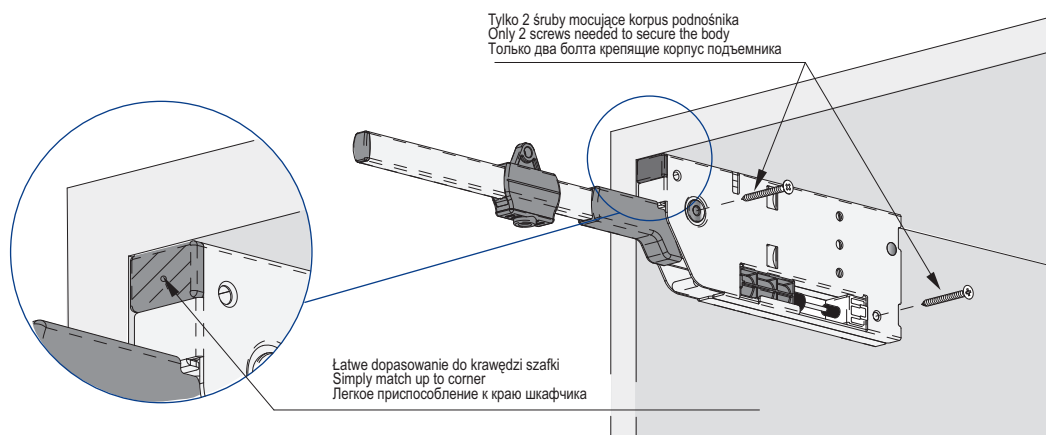

Waga kłapy (kg)

	1,5	2	2,5	3	3,5	4	4,5	5	5,5	6	6,5	7	7,5	8	8,5	9	9,5	10
320					Mx1	Mx1	Mx1	Hx1	Hx1	Hx1	Mx2	Mx2	Mx2	Mx2	Mx2	Mx2	Hx2	Hx2
340				Mx1	Mx1	Mx1	Hx1	Hx1	Hx1	Mx2	Mx2	Mx2	Mx2	Mx2	Mx2	Hx2	Hx2	Hx2
360				Mx1	Mx1	Mx1	Hx1	Hx1	Hx1	Mx2	Mx2	Mx2	Mx2	Mx2	Hx2	Hx2	Hx2	Hx2
380				Mx1	Mx1	Hx1	Hx1	Hx1	Mx2	Mx2	Mx2	Mx2	Mx2	Hx2	Hx2	Hx2	Hx2	Hx2
400			Mx1	Mx1	Mx1	Hx1	Hx1	Mx2	Mx2	Mx2	Mx2	Mx2	Hx2	Hx2	Hx2	Hx2	Hx2	Hx2
420			Mx1	Mx1	Mx1	Hx1	Hx1	Mx2	Mx2	Mx2	Mx2	Mx2	Hx2	Hx2	Hx2	Hx2	Hx2	Hx2
440			Mx1	Mx1	Hx1	Hx1	Hx1	Mx2	Mx2	Mx2	Mx2	Hx2	Hx2	Hx2	Hx2	Hx2		
460			Mx1	Mx1	Hx1	Hx1	Mx2	Mx2	Mx2	Mx2	Mx2	Hx2	Hx2	Hx2	Hx2			
480			Mx1	Mx1	Hx1	Hx1	Mx2	Mx2	Mx2	Mx2	Hx2	Hx2	Hx2	Hx2				
500		Mx1	Mx1	Hx1	Hx1	Mx2	Mx2	Mx2	Mx2	Hx2	Hx2	Hx2	Hx2					
520		Mx1	Mx1	Hx1	Hx1	Mx2	Mx2	Mx2	Mx2	Hx2	Hx2	Hx2						
540		Mx1	Mx1	Hx1	Hx1	Mx2	Mx2	Mx2	Mx2	Hx2	Hx2							
560		Mx1	Mx1	Hx1	Hx1	Mx2	Mx2	Mx2	Hx2	Hx2								
580		Mx1	Mx1	Hx1	Mx2	Mx2	Mx2	Mx2	Hx2	Hx2								
600		Mx1	Hx1	Hx1	Mx2	Mx2	Mx2	Hx2	Hx2									
620		Mx1	Hx1	Mx2	Mx2	Mx2	Hx2	Hx2										
640		Mx1	Hx1	Mx2	Mx2	Mx2	Hx2											
660		Mx1	Hx1	Mx2	Mx2	Mx2	Hx2											
680	Mx1	Mx1	Hx1	Mx2	Mx2	Mx2	Hx2											
700	Mx1	Mx1	Hx1	Mx2	Mx2	Mx2	Hx2											

Powyższa tabela została stworzona dla celów informacyjnych i nie stanowi gwarancji producenta. Końcowa instalacja powinna zawsze zostać sprawdzona przed oddaniem do użytku.

Indeks / Index / Индекс	Typ / Type / Тип	Wykończenie / Finish Colour / Отделка Цвет	Waga / Weight / Вес
PD-ELAN00-MR	prawy / right / правый	Typ M (do kłap lekkich) / M-type (Medium Duty) / Тип M (для лёгкого клапана)	600g
PD-ELAN00-ML	lewy / left / левый	anodized galvanized light grey	
PD-ELAN00-HR	prawy / right / правый	Typ H (do kłap ciężkich) / H-type (Heavy Duty) / Тип H (для клапанов тяжёлых)	600g/r.
PD-ELAN00-HL	lewy / left / левый	anodирование гальванизация светло-серый	

# Podnośnik gazowy

Gas lift / Газовый подъёмник

Index: PD-GO...-N02  
(N)

## Cechy produktu / Features / Характеристика товара:

- Dostępne opory: 60N, 80N, 100N, 120N, 150N  
Available resistances: 60N, 80N, 100N, 120N, 150N  
Доступные силы сопротивления: 60N, 80N, 100N, 120N, 150N
- Opakowanie: blister  
Packing: blister  
Упаковка: блистер



 stal / steel / сталь  
material

 color

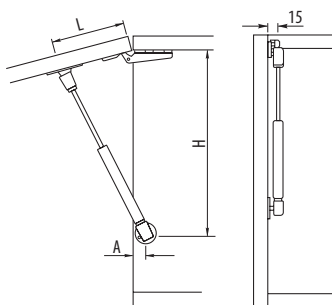

### Drzwi wpuszczane / Flush door / Внутренние дверцы

Kąt otwarcia drzwi Door opening angle Угол открытия дверей	H mm	L mm	A mm
75°	260	100	45
90°	255	90	45
110°	250	80	45

### Drzwi bliźniacze / Twin door / Двойные дверцы

Kąt otwarcia drzwi Door opening angle Угол открытия дверей	H mm	L mm	A mm
75°	253	100	25
90°	248	90	25
110°	243	80	25

### Drzwi nakładane / Lift-off door / Наружные дверцы

Kąt otwarcia drzwi Door opening angle Угол открытия дверей	H mm	L mm	A mm
75°	246	100	25
90°	241	90	25
110°	236	80	25

### Sila podnośnika dla kąta 75° Lift force for angle of 75°

Мощность подъёмника при открытии под углом 75°

Sila podnośnika Load capacity Мощность подъёмника (N)	Wysokość drzwi / Door height / Высота дверцы (mm) Waga drzwi / Door weight / Вес дверцы (kg)			
	300	400	500	600
60	2.0	1.5	1.2	1.0
80	2.7	2.0	1.6	1.4
100	3.4	2.6	2.0	1.7
120	4.1	3.1	2.5	2.0
150	4.7	3.5	2.9	2.4

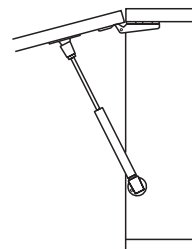

### Sila podnośnika dla kąta 90° Lift force for angle of 90°

Мощность подъёмника при открытии под углом 90°

Sila podnośnika Load capacity Мощность подъёмника (N)	Wysokość drzwi / Door height / Высота дверцы (mm) Waga drzwi / Door weight / Вес дверцы (kg)			
	300	400	500	600
60	1.8	1.3	1.1	0.9
80	2.4	1.8	1.4	1.2
100	3.0	2.2	1.8	1.5
120	3.6	2.7	2.1	1.8
150	4.1	3.2	2.3	2.1

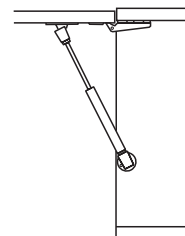

### Sila podnośnika dla kąta 110° Lift force for angle of 110°

Мощность подъёмника при открытии под углом 110°

Sila podnośnika Load capacity Мощность подъёмника (N)	Wysokość drzwi / Door height / Высота дверцы (mm) Waga drzwi / Door weight / Вес дверцы (kg)			
	300	400	500	600
60	1.6	1.2	0.9	0.8
80	2.1	1.6	1.2	1.0
100	2.6	1.9	1.6	1.3
120	3.1	2.3	1.9	1.6
150	3.5	2.6	2.2	1.9

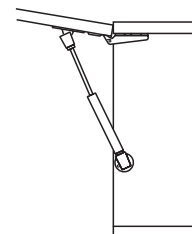

# Podnośnik olejowy barkowy dolny

Oil lift down / Подъемник барный нижний масляный

Index: PD-DL...-N02  
(N)

### Cechy produktu / Features / Характеристика товара:

- Dostępne opory: 80N, 150N  
Available resistances: 80N, 150N  
Доступные силы сопротивления: 80N, 150N
- Opakowanie: blister  
Packing: blister  
Упаковка: блистер



material

stal / steel / сталь



color



Siła podnośnika dla kąta 90°

Lift force for angle of 90°

Мощность подъемника при открытии под углом 90°

Siła podnośnika Load capacity Мощность подъемника (N)	Wysokość drzwi / Door height / Высота дверцы (mm) Waga drzwi / Door weight / Вес дверцы (kg)			
	300	400	500	600
60	1.8	1.3	1.1	0.9
80	2.4	1.8	1.4	1.2
100	3.0	2.2	1.8	1.5
120	3.6	2.7	2.1	1.8
150	4.1	3.2	2.3	2.1

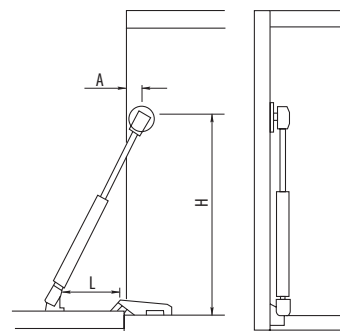
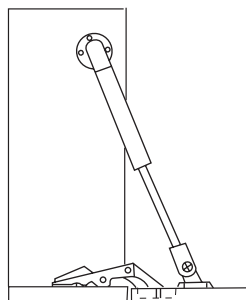

Drzwi wpuszczane / Flush door / Внутренние дверцы

Kąt otwarcia drzwi Door opening angle Угол открытия дверей	H mm	L mm	A mm
90°	260	90	45
110°	255	80	45

Siła podnośnika dla kąta 110°

Lift force for angle of 110°

Мощность подъемника при открытии под углом 110°

Siła podnośnika Load capacity Мощность подъемника (N)	Wysokość drzwi / Door height / Высота дверцы (mm) Waga drzwi / Door weight / Вес дверцы (kg)			
	300	400	500	600
60	1.6	1.2	0.9	0.8
80	2.1	1.6	1.2	1.0
100	2.6	1.9	1.6	1.3
120	3.1	2.3	1.9	1.6
150	3.5	2.6	2.2	1.9

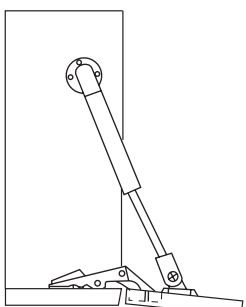

Drzwi bliźniacze / Twin door / Двойные дверцы

Kąt otwarcia drzwi Door opening angle Угол открытия дверей	H mm	L mm	A mm
90°	253	90	25
110°	248	80	25

Drzwi nakładane / Lift-off door / Наружные дверцы

Kąt otwarcia drzwi Door opening angle Угол открытия дверей	H mm	L mm	A mm
90°	246	90	25
110°	241	80	25

# Podnośnik gazowy - długość 160 mm

Gas lift - length 160 mm / Газовый подъёмник – длина 160 мм

Index: PD-G..160-02  
(N)

## Cechy produktu / Features / Характеристика товара:

- Dostępne opory: 60N, 80N  
Available resistances: 60N, 80N  
Доступные силы сопротивления: 60N, 80N
- Opakowanie: blister  
Packing: blister  
Упаковка: блистер

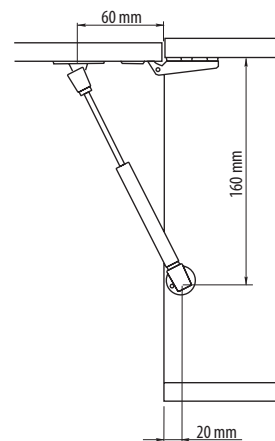

Siła podnośnika dla kąta 75°  
Lift force for angle of 75°  
Мощность подъёмника при открытии под углом 75°

Siła podnośnika Load capacity Мощность подъёмника (N)	Wysokość drzwi / Door height / Высота дверцы (mm) Waga drzwi / Door weight / Вес дверцы (kg)			
	300	400	500	600
60	2.0	1.5	1.2	1.0
80	2.7	2.0	1.6	1.4
100	3.4	2.6	2.0	1.7
120	4.1	3.1	2.5	2.0
150	4.7	3.5	2.9	2.4

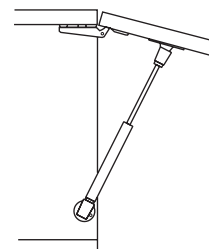

Siła podnośnika dla kąta 90°  
Lift force for angle of 90°  
Мощность подъёмника при открытии под углом 90°

Siła podnośnika Load capacity Мощность подъёмника (N)	Wysokość drzwi / Door height / Высота дверцы (mm) Waga drzwi / Door weight / Вес дверцы (kg)			
	300	400	500	600
60	1.8	1.3	1.1	0.9
80	2.4	1.8	1.4	1.2
100	3.0	2.2	1.8	1.5
120	3.6	2.7	2.1	1.8
150	4.1	3.2	2.3	2.1

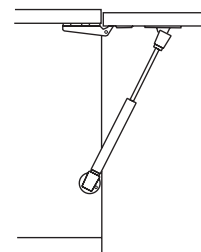

Siła podnośnika dla kąta 110°  
Lift force for angle of 110°  
Мощность подъёмника при открытии под углом 110°

Siła podnośnika Load capacity Мощность подъёмника (N)	Wysokość drzwi / Door height / Высота дверцы (mm) Waga drzwi / Door weight / Вес дверцы (kg)			
	300	400	500	600
60	1.6	1.2	0.9	0.8
80	2.1	1.6	1.2	1.0
100	2.6	1.9	1.6	1.3
120	3.1	2.3	1.9	1.6
150	3.5	2.6	2.2	1.9

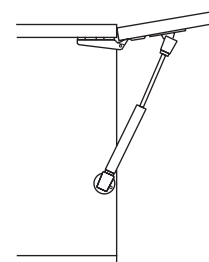

 stal / steel / сталь  
material

  80  
color

## Podnośnik do mikrofalni

Microwave oven lift / Подъёмник для микроволновой печи

Index: PD-PDS00-001

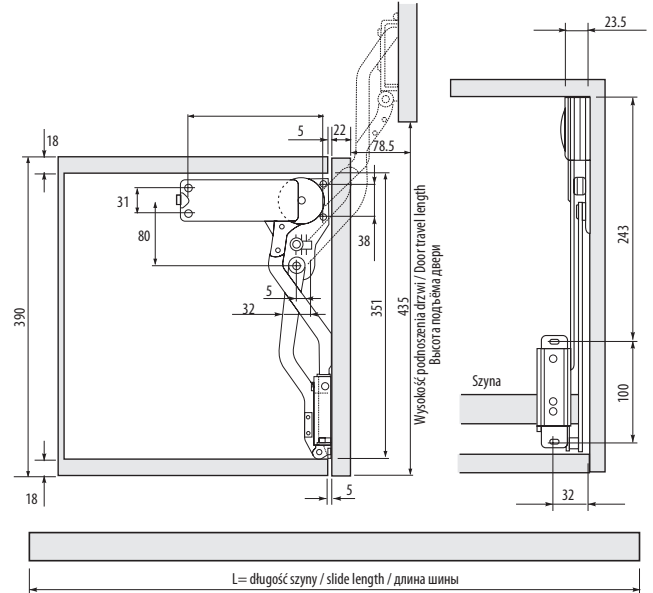
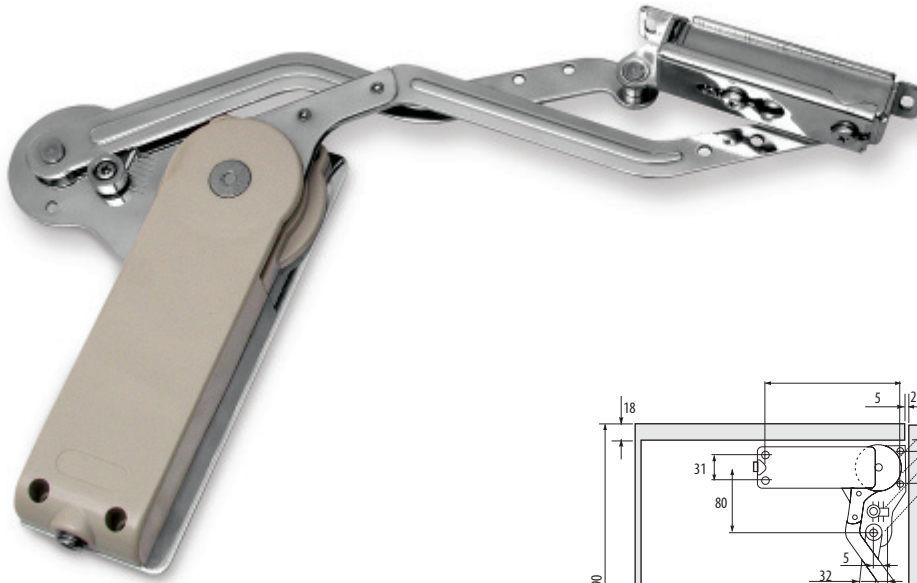

Długość szyny / Slide length / Длина шины

	Szerokość szafki Cabinet width Ширина шкафчика =600mm (24")	Szerokość szafki Cabinet width Ширина шкафчика =900mm (36")
Drzwi pełne (A) / Solid wooden door (A) Полная дверь (A)	535mm	835mm
Drzwi ramkowe (B) / Frame door (B) Рамочная дверь (B)	551mm	851mm



stal / steel / сталь

## Podnośnik do drzwi łamanych

Folding door lift / Подъёмник к дверям

Index: PD-PDL00-001

**Cechy produktu / Features / Характеристика товара:**

- W sprzedaży bez zawiasów  
On sale without hinges  
В продаже без петель

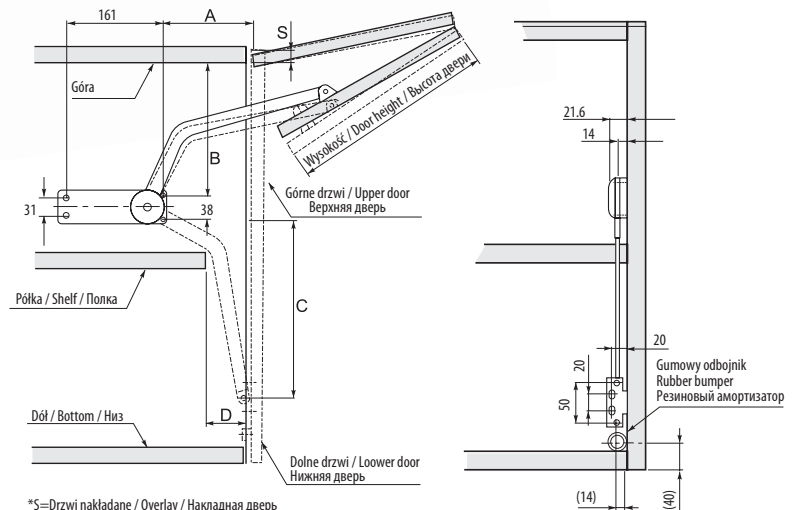
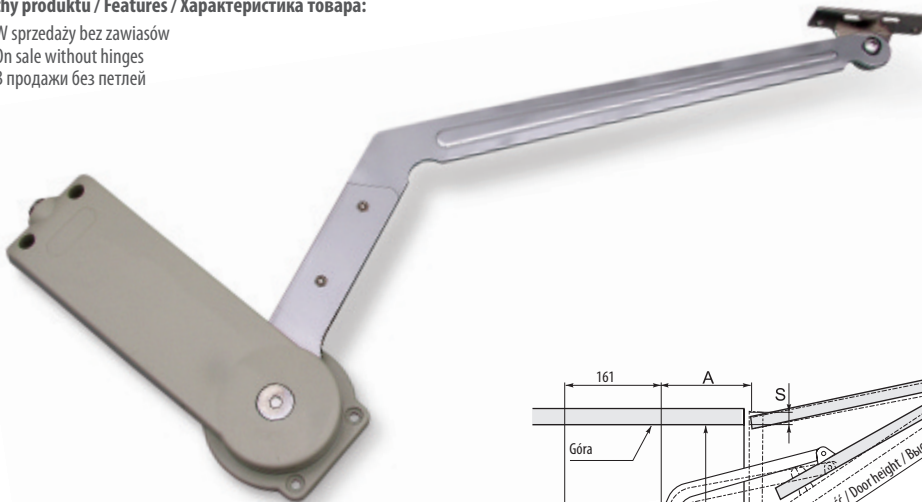

\*S=Drzwi nakładane / Overlay / Накладная дверь



stal / steel / сталь

# Podnośnik mechaniczny „DESIGN”

Mechanical lift „DESIGN” / Механический подъёмник DESIGN

Index: PD-GPD01-...

## Cechy produktu / Features / Характеристика товара:

- Dowlolny montaż (lewy lub prawy)  
Optional mounting (left or right)  
Любой способ монтажа (левая или правая стороны)



stal / steel / сталь



color

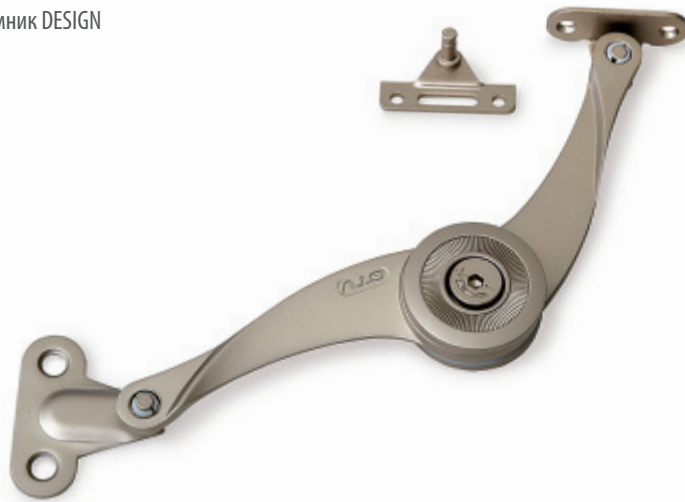

Drzwi nakładane 75° / Lift-off door 75° / Наружные дверцы 75°

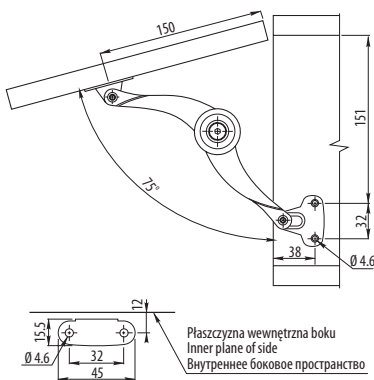

Drzwi nakładane 90° / Lift-off door 90° / Наружные дверцы 90°

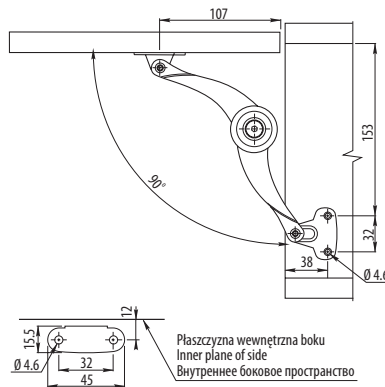

Drzwi nakładane 100° / Lift-off door 100° / Наружные дверцы 100°

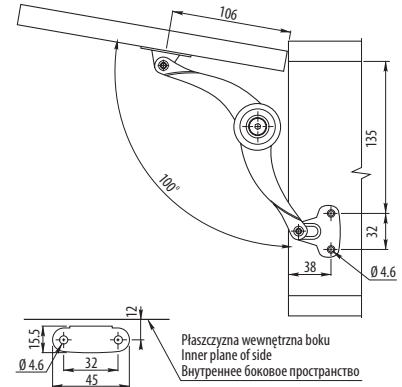

# Podnośnik mechaniczny

Mechanical lift / Механический подъёмник

Index: PD-PD000-001

## Cechy produktu / Features / Характеристика товара:

- Dowlolny montaż (lewy lub prawy)  
Optional mounting (left or right)  
Любой способ монтажа (левая или правая стороны)



stal / steel / сталь



color



Drzwi nakładane 75° / Lift-off door 75° / Наружные дверцы 75°

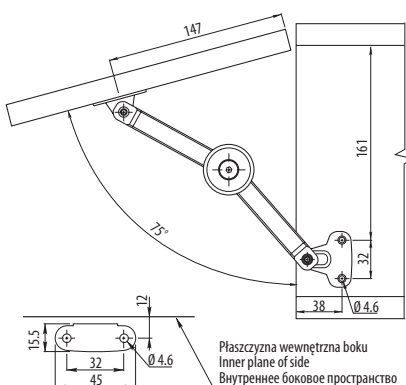

Drzwi nakładane 90° / Lift-off door 90° / Наружные дверцы 90°

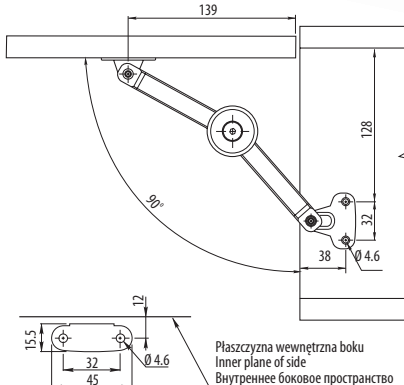

Drzwi nakładane 100° / Lift-off door 100° / Наружные дверцы 100°

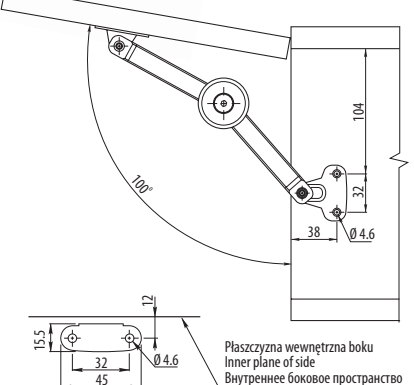

# Podnośnik hydrauliczny, lewy i prawy

Hydraulic lift left/right / Гидравлический подъёмник правый и левый

Index: PD-PHL00-001, PD-PHP00-001

lewy / left / левая      prawy / right / правая

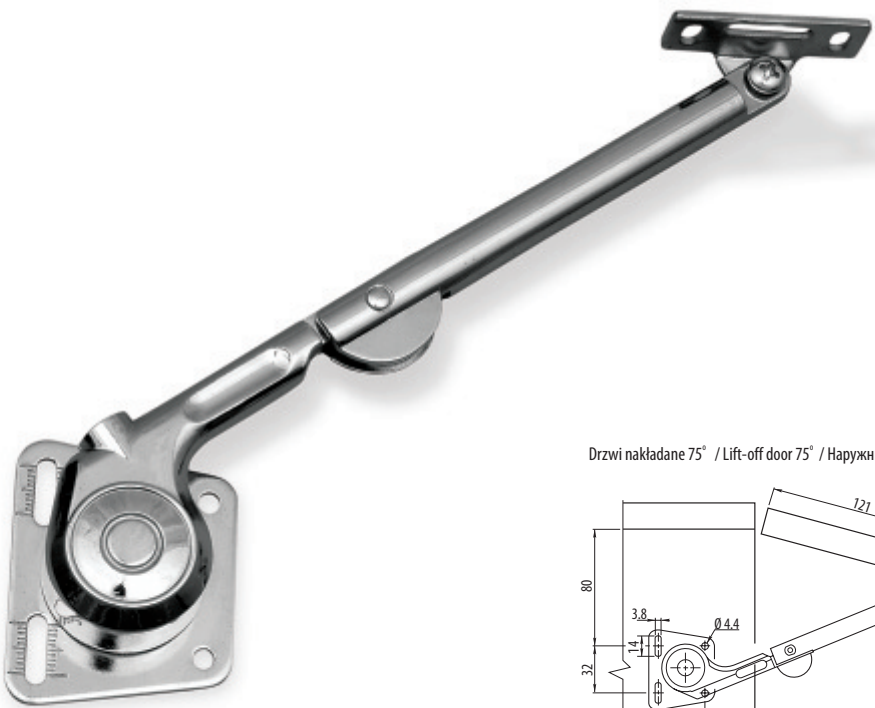

Drzwi nakładane 75° / Lift-off door 75° / Наружные дверцы 75°

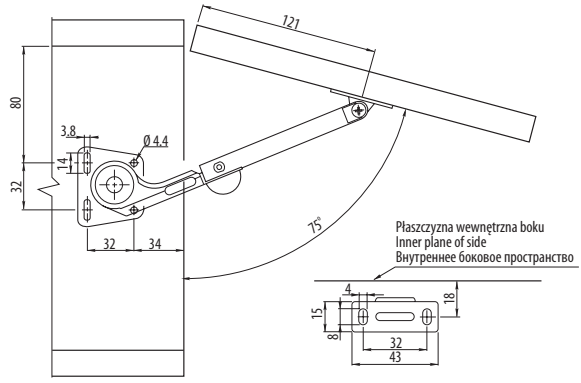

Drzwi nakładane 90° / Lift-off door 90° / Наружные дверцы 90°

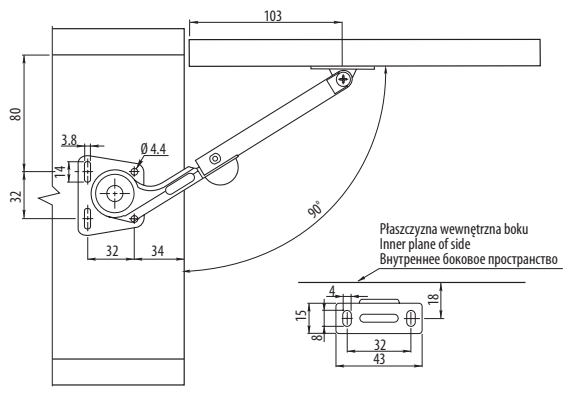

Drzwi nakładane 100° / Lift-off door 100° / Наружные дверцы 100°

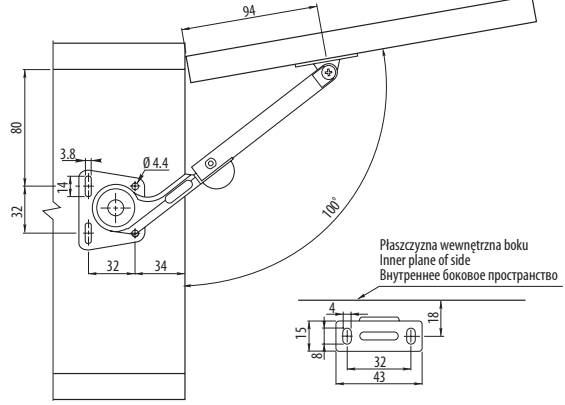

 stal / steel / сталь



 color

Index	Strona / Page / Страница	Index	Strona / Page / Страница
AM-ADAP0A-60	16	ZM-ECHC09..0	8
AM-ADAP0B-60	16	ZM-HCKT30-BE	10
AM-KRZYZ-KPL	15	ZM-HCKT45-BE	10
AM-ODB000-60	16	ZM-HCKT90-BE	11
AM-PL-DL-MAG	16	ZM-HCRALU9BE	13
AM-PLA-DLU-0	16	ZP-BICN07...	2
AM-PROST-KPL	15	ZP-BICN08...	1
PD-ELAN-00-..	17	ZP-BICN09...	1
PD-ELANRA-00	17	ZP-CI07H0...	3
PD-DL...-N02	20	ZP-CI08H0...	3
PD-PDS00-001	22	ZP-CI09H0...	2
PD-G..160-02	21	ZP-CIG-07...	12
PD-GO...-N02	19	ZP-CIG-09...	12
PD-GPD01-...	23	ZP-CIHC090ZE	9
PD-PDL00-001	22	ZP-CONL07-..	7
PD-PD000-001	23	ZP-CONL08-..	7
PD-PHL00-001	24	ZP-CONL09-..	6
PD-PHP00-001	24	ZP-JUNIOR-00	11
PZ-BI-...-BEO	15	ZP-KT30H2-..	4
PZ-BI-...-ZEO	15	ZP-KT45H2-..	4
ZC-GTV-12-00	14	ZP-KT90H2-..	5
ZC-GTV-14-00	14	ZP-KT135H2..	5
ZM-CNHC07-..	9	ZP-KT165H2..	6
ZM-CNHC08-..	8	ZP-RALUH2-00	13
ZM-CNHC09-..	8	ZT-HF-01-M00	14
ZM-ECHC07..0	9	ZT-HF-01-D00	14
ZM-ECHC08..0	8		

Pokrycia galwaniczne / Galvanic coatings  
Шаблон гальванических покрытий

01		chrom / chrome / хром
02		satyna / satin / сатин
03		mosiądz / brass / золото
04		stary mosiądz / antique brass / старое золото
05		aluminium / алюминий
06		stal szcztotkowana / brushed steel / шлифованная сталь

Pokrycia lakiernicze / Enamel coatings  
Шаблон лакированных покрытий

10		biały / white / белый
20		czarny / black / чёрный

WWW.GTV.COM.PL

**GTV**

*ul. Przejazdowa 21  
05-800 Pruszków  
Poland*

*tel. + 48 22 444 75 00  
fax + 48 22 444 75 01  
mail: info@werkpol.pl*

*www.gtv.com.pl*

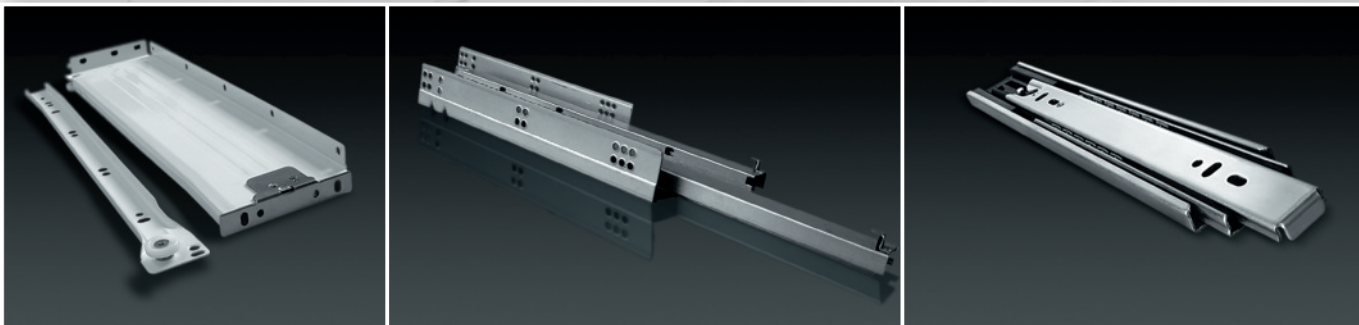

***Prowadnice • Slides • Направляющие***

# Prowadnica kulkowa 17 mm

Ball bearing slide 17 mm / Шариковая направляющая 17 mm

Index: PK-0-H17-...  
(L)



## Cechy produktu / Features / Характеристика товара:

- łożysko kulowe / ball bearing / шариковый подшипник
- końcowa blokada wysuwu (zapobiega wypadaniu szuflady) / sliding end lock (prevents the drawer from falling out) / конечная блокировка выдвижения (препятствует выпадению ящика)
- dopuszczalne obciążenie dla długości do 342 mm - 10 kg, powyżej – 8 kg / allowable load for the length up to 342 mm - 10 kg, over – 8 kg / допустимая нагрузка для длины 342 мм - 10 кг, выше - 8 кг

## Głębokość wysuwu / Sliding depth / Глубина выдвижения

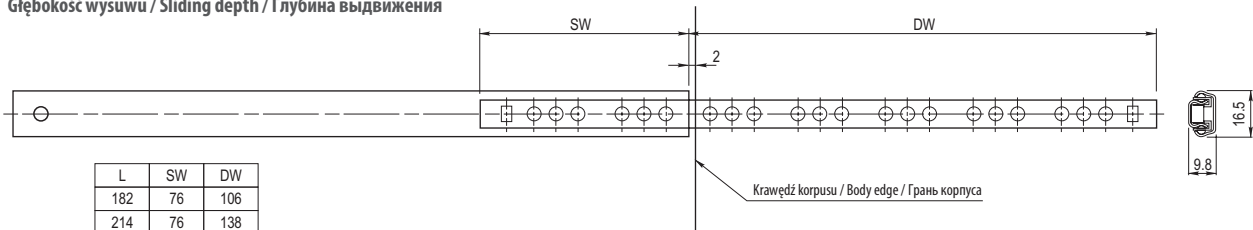

L	SW	DW
182	76	106
214	76	138
246	76	167
278	76	202
310	100	210
342	97	245
406	97	309
438	100	338

L - Długość prowadnicy / Guide length / Длина направляющей  
 SW - Strata długości wysuwu / Sliding length loss / Потеря длины выдвижения  
 DW - Rzeczywista długość wysuwu / Real sliding length / Действительная длина выдвижения

## Montaż prowadnicy / Guide mounting / Монтаж направляющей

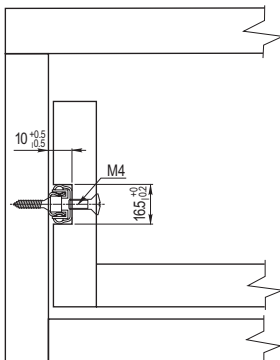

## Schemat prowadnicy szuflady dla L=182 mm / Drawer guide scheme for L=182 mm / Схема направляющей для ящика L=182 mm

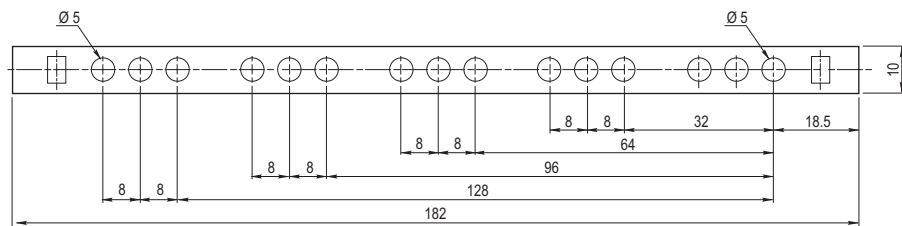

## Schemat prowadnicy korpusu dla L=182 mm / Body guide scheme for L=182 mm / Схема направляющей корпуса для L=182 mm

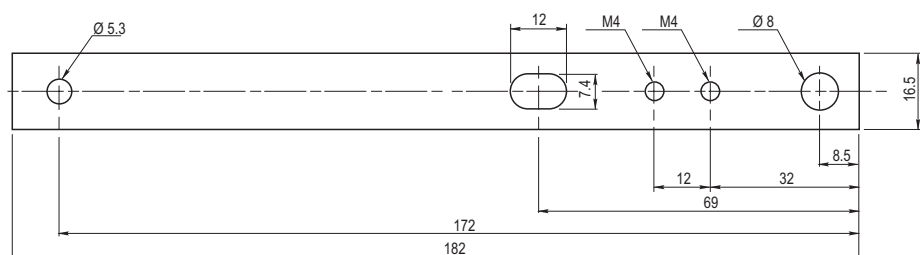

stal / steel / сталь

material



H=17

L=182, 214, 246, 278, 310, 342, 406, 438

size

## Prowadnica kulkowa 35 mm

Index: PK-0H35-...0  
(L)

Ball bearing slide 35 mm / Шариковая направляющая 35 mm



### Cechy produktu / Features / Характеристика товара:

- łożysko kulowe / ball bearing / шариковый подшипник
- teleskopowa budowa prowadnika / telescopic slider construction / телескопическая структура направляющей
- dostępne w wersji z pełnym wysuwem / available in full sliding version / доступен вариант с полным выдвиганием
- gumowy hamulec zapobiegający samoczynnemu otwieraniu / rubber brake preventing from automatic opening / резиновый тормоз, препятствующий автоматическому открытию
- możliwość demontażu części prowadnika, co ułatwia mocowanie prowadnicy / possibility of dismantling part of a slider which makes guide mounting easier  
возможность разборки части направляющей, что облегчает монтаж направляющей
- dopuszczalne obciążenie dla długości do 450 mm – 25 kg, powyżej - 20 kg / allowable load for the length up to 450 mm – 25 kg, over - 20 kg  
допускаемая нагрузка для длины 450 мм - 25 кг, выше - 20 кг

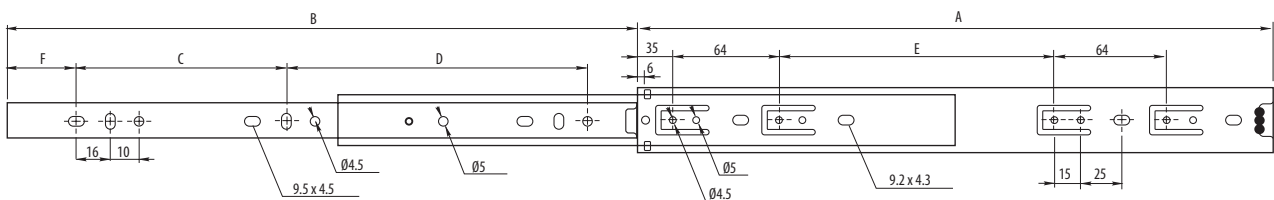

A	B	C	D	E	F
250	247	C+D=190	75	28	
300	297	113	113	124	35
350	347	138	138	110	35
400	397	163	163	160	35
450	447	188	188	210	35
500	497	213	213	260	35



stal / steel / сталь

material



H = 35

L = 250, 300, 350, 400, 450, 500

size

# Prowadnica kulkowa 45 mm PRESTIGE

Index: PK-0-H45-...  
(L)

Ball bearing slide 45 mm PRESTIGE / Шариковая направляющая 45 mm PRESTIGE

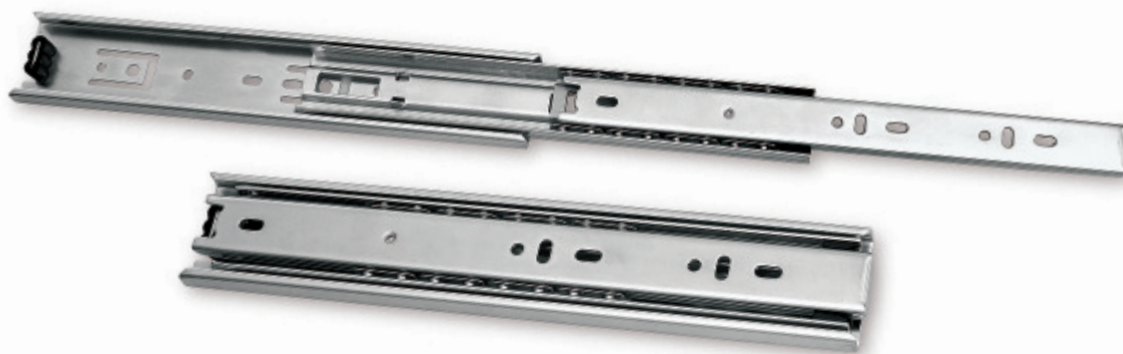

## Cechy produktu / Features / Характеристика товара:

- dostępne w wersji z pełnym wysuwem / available in full sliding version / доступен вариант с полным выдвиганием
- łożysko kulowe / ball bearing / шариковый подшипник
- teleskopowa budowa prowadnika / telescopic slider construction / телескопическая структура башмака
- gumowy hamulec zapobiegający samoczynnemu otwieraniu / rubber brake preventing from automatic opening  
резиновый тормоз, предупреждающий автоматическому открытию
- możliwość demontażu części prowadnika, co ułatwia mocowanie prowadnicy / possibility of dismantling part of a slider which makes guide mounting easier  
возможность разборки части башмака, что облегчает монтаж направляющей
- dopuszczalne obciążenie 35 kg / allowable load 35 kg / допустимая нагрузка 35 кг

Schemat prowadnicy szuflady dla L=250 mm / Drawer guide scheme for L=250 mm  
Схема направляющей ящика для L=250 мм

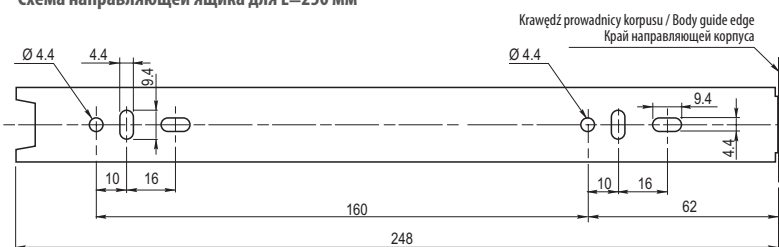

Wymiary montażowe / Mounting dimensions  
Монтажные размеры

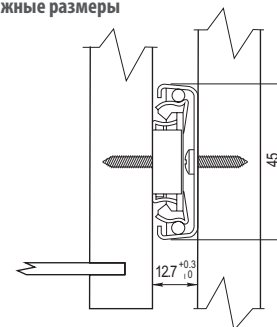

Schemat prowadnicy korpusu dla L=250 mm / Body guide scheme for L=250 mm  
Схема направляющей корпуса для L=250 мм

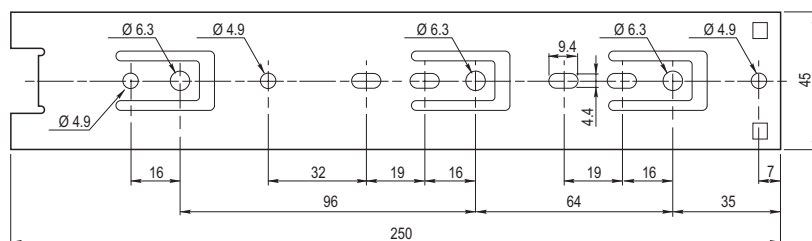

Pozycja mocowania prowadnic korpusu  
Fixing position of body guides  
Место крепления направляющих корпуса

Długość  
Length  
Длина  
L

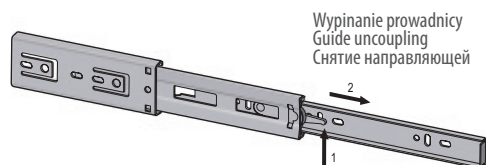
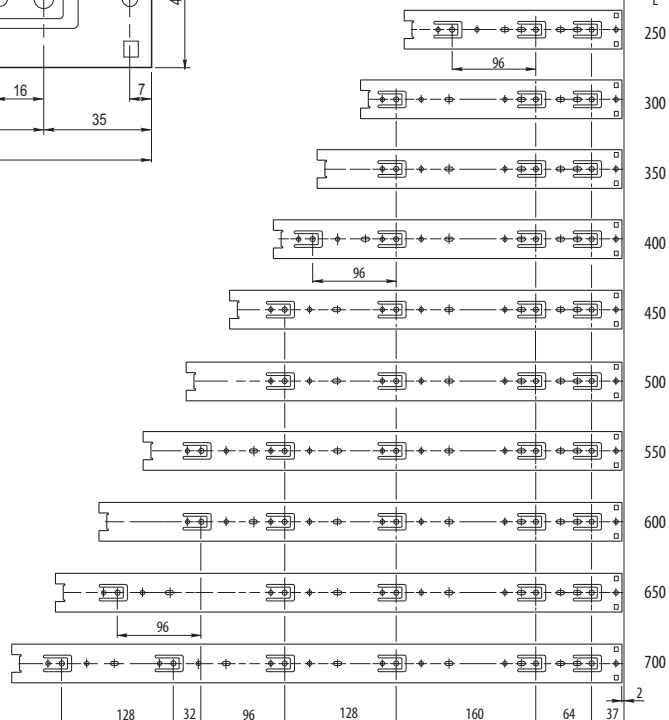

stal / steel / сталь

material



H = 45

L = 250, 300, 350, 400, 450, 500, 550, 600, 650, 700

size

## Prowadnica kulkowa 45 mm XP

Ball bearing slide 45 mm XP / Шариковая направляющая 45 mm XP

Index: PK-0H45...XP  
(L)



### Cechy produktu / Features / Характеристика товара:

- łożysko kulowe / ball bearing / шариковый подшипник
- teleskopowa budowa prowadnika / telescopic slider construction / телескопическая структура башмака
- dostępne w wersji z pełnym wysuwem / available in full sliding version / доступен вариант с полным выдвиганием
- gumowy hamulec zapobiegający samoczynnemu otwieraniu / rubber brake preventing from automatic opening / резиновый тормоз, предупреждающий автоматическому открытию
- możliwość demontażu części prowadnika, co ułatwia mocowanie prowadnicy / possibility of dismantling part of a slider which makes guide mounting easier / возможность разборки части башмака, что облегчает монтаж направляющей
- dopuszczalne obciążenie 30 kg / allowable load 30 kg / допустимая нагрузка 30 кг

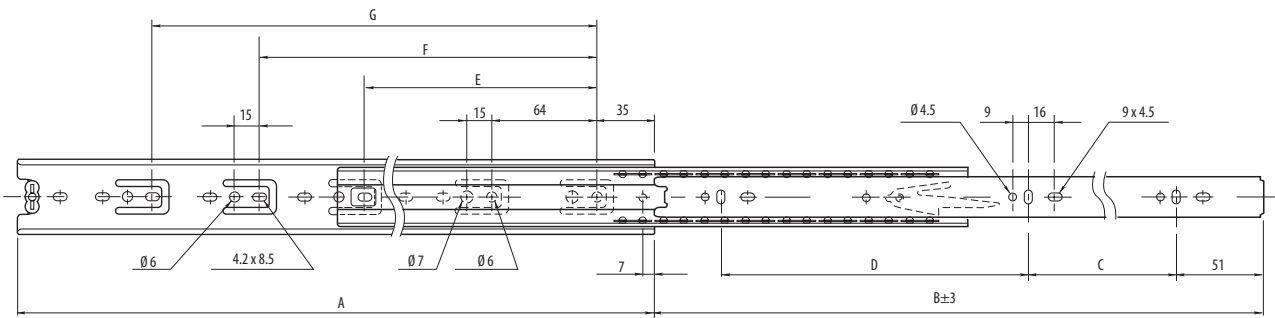

A	B	C	D	E	F	G
250	250	160	-	160	-	-
300	300	96	128	192	-	-
350	350	96	160	224	-	-
400	400	128	192	224	288	-
450	450	160	192	224	352	-
500	500	192	224	224	352	-
550	550	192	256	224	352	448
600	600	224	288	224	352	448
650	650	256	288	224	352	544

### Pozycja mocowania prowadnic korpusu Fixing position of body guides Место крепления направляющих корпуса

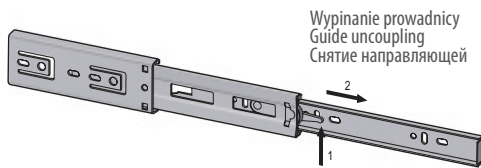
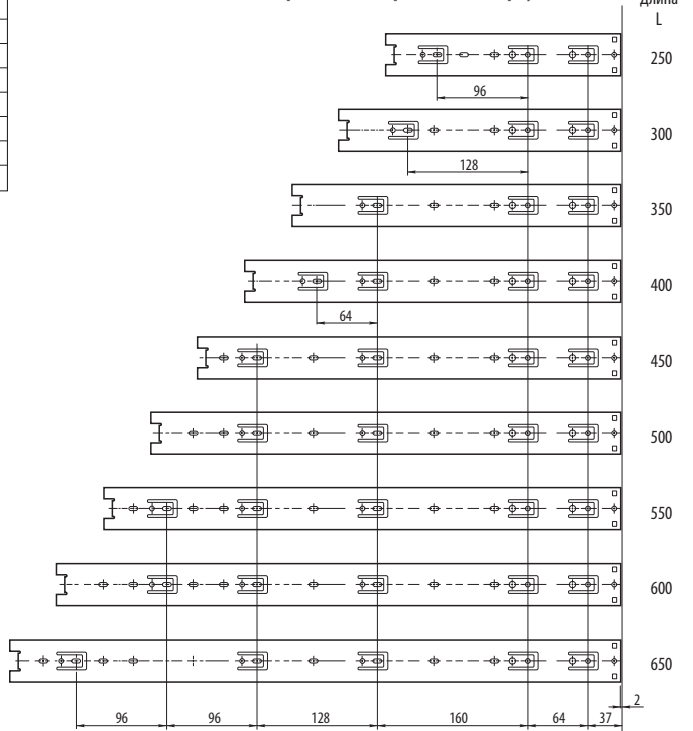

material

stal / steel / сталь



size

H = 45

L = 250, 300, 350, 400, 450, 500, 550, 600

# Prowadnica kulkowa z samodociągiem 45 mm PRESTIGE

Index: PK-S-H-45...  
(L)

Ball bearing slide with autolock function 45 mm PRESTIGE / Шариковая направляющая 45 мм ПРЕСТИЖ с механизмом самодоката



## Cechy produktu / Features / Характеристика товара:

- dostępne w wersji z pełnym wysuwem / available in full sliding version / доступен вариант с полным выдвижением
- łożysko kulowe / ball bearing / шариковый подшипник
- teleskopowa budowa prowadnika / telescopic slider construction / телескопическая структура башмака
- mechanizm samodociągu bez funkcji cichego domytku / auto-drawing-up mechanism without quiet shut function / механизм самодоката без функции бесшумного доката
- możliwość demontażu części prowadnika, co ułatwia mocowanie prowadnicy / possibility of dismantling part of a slider which makes guide mounting easier / возможность разборки части башмака, что облегчает монтаж направляющей
- dopuszczalne obciążenie 35 kg / allowable load 35 kg / допустимая нагрузка 35 кг

Schemat prowadnicy szuflady dla L=250 mm / Drawer guide scheme for L=250 mm  
Схема направляющей ящика для L=250 мм

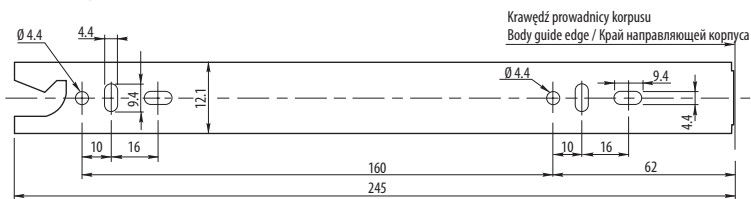

Wymiary montażowe / Mounting dimensions  
Монтажные размеры

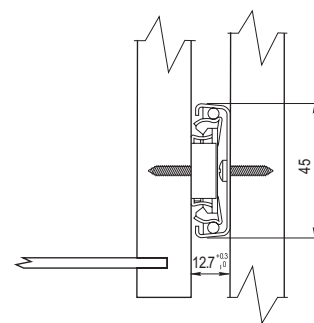

Schemat prowadnicy korpusu dla L=250 mm / Body guide scheme for L=250 mm  
Схема направляющей корпуса для L=250 мм

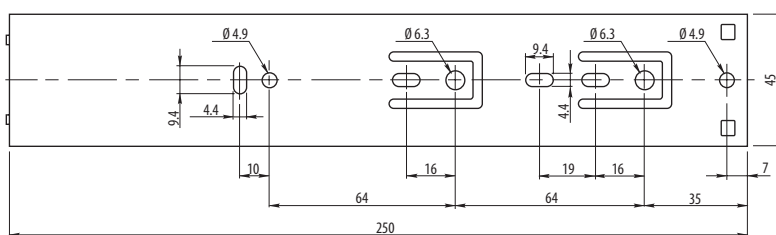

Pozycja mocowania prowadnic korpusu  
Fixing position of body guides  
Место крепления направляющих корпуса

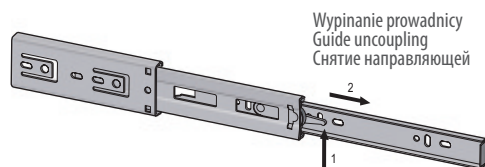
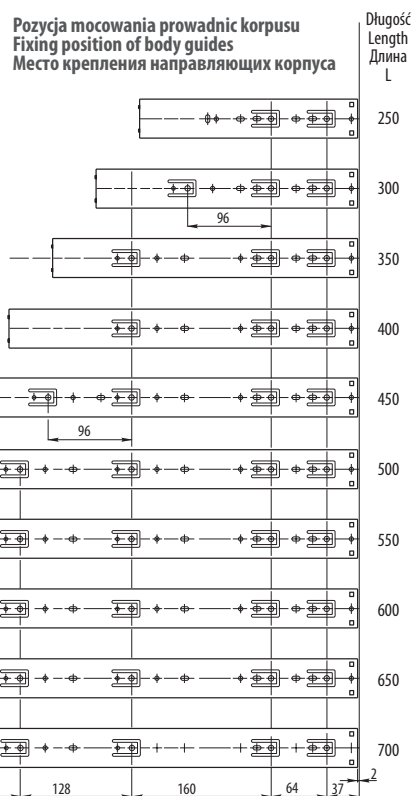

stal / steel / сталь

material



H = 45

L = 250, 300, 350, 400, 450, 500, 550, 600, 650, 700

size

# Prowadnica kulkowa ze spowalniaczem 45 mm PRESTIGE

Index: PK-SPH45...0  
(L)

Ball bearing slide with soft closing function 45 mm PRESTIGE/ Шариковая направляющая с функцией бесшумного самодоката 45 mm PRESTIGE



### Cechy produktu / Features / Характеристика товара:

- dostępna w wersji z pełnym wysuwem i ¾ wysuwu / available in full sliding and ¾ sliding version  
доступна версия с полным выдвигением и ¾ выдвигения
- łożysko kulowe / ball bearing / шариковый подшипник
- teleskopowa budowa prowadnika / telescopic slider construction / телескопическая структура башмака
- mechanizm samodociągu z funkcją cichego domytku, bez funkcji „reset” / auto-drawing-up mechanism with quiet shut function, without “reset” function  
механизм самодоката с функцией бесшумного доката, без функции “ресет”
- możliwość demontażu części prowadnika, co ułatwia mocowanie prowadnicy / possibility of dismantling part of a slider which makes guide mounting easier  
возможность разборки части башмака, что облегчает монтаж направляющей
- dopuszczalne obciążenie dla długości do 450 mm – 40 kg, 500 mm – 38 kg, 550 mm – 36 kg, 600 mm – 34 kg, 650 mm – 32 kg, 700 mm – 30 kg  
allowable load for the length up to 450 mm – 25 kg, 500 mm – 38 kg, 550 mm – 36 kg, 600 mm – 34 kg, 650 mm – 32 kg, 700 mm – 30 kg  
допускаемая нагрузка для длины 450 мм - 25 кг, 500 мм – 38 кг, 550 мм – 36 кг, 600 мм – 34 кг, 650 мм – 32 кг, 700 мм – 30 кг

Schemat prowadnicy korpusu dla L=300 mm / Body guide scheme for L=300 mm  
Схема направляющей корпуса для L=300 мм

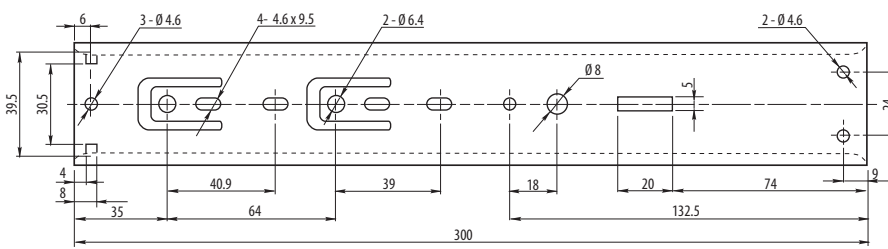

Wymiary montażowe / Mounting dimensions  
Монтажные размеры

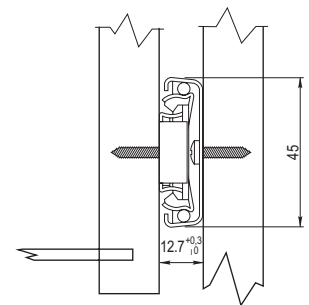

Schemat prowadnicy szuflady dla L=300 mm / Drawer guide scheme for L=300 mm  
Схема направляющей ящика для L=300 мм

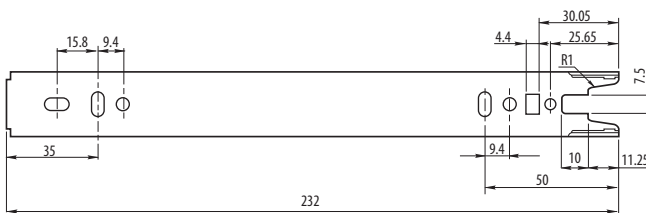

Pozycja mocowania prowadnic korpusu  
Fixing position of body guides  
Место крепления направляющих корпуса

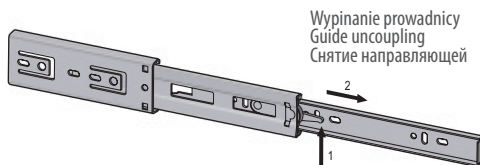
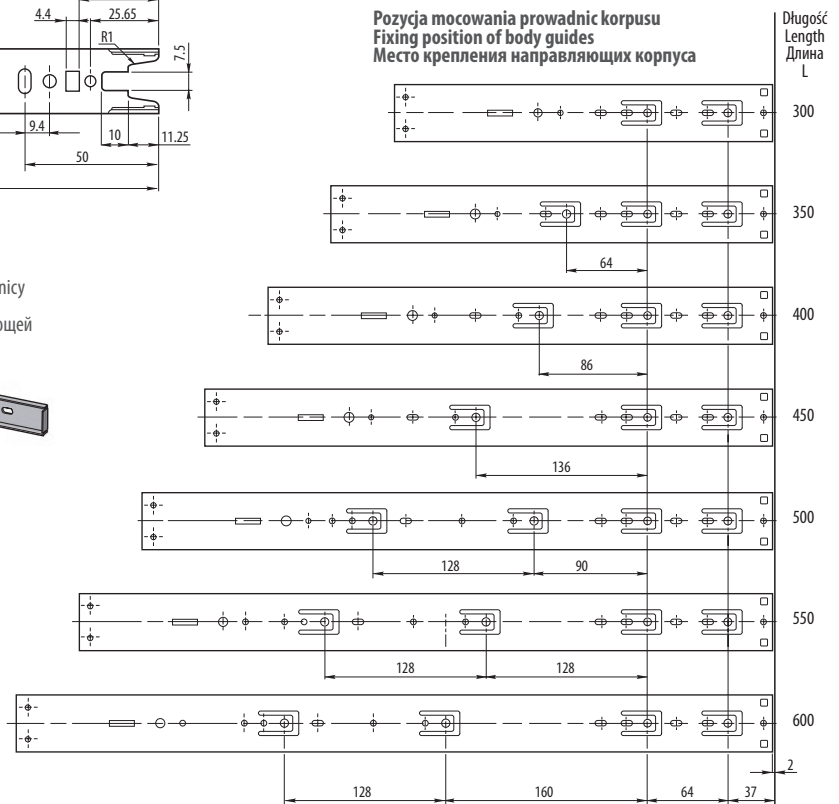

Wyupinanie prowadnicy  
Guide uncoupling  
Снятие направляющей



material

stal / steel / сталь



size

H=45

L=300, 350, 400, 450, 500, 550, 600

# Prowadnica do szuflad drewnianych

Under mounting slide for wooden drawers with slow closing function / Направляющая для деревянных ящиков

Index: PB-DRW...-00\*<sup>(L)</sup>, PB-DOL...-00\*\*<sup>(L)</sup>

\* 3/4  
\*\* pełny wysuw / full sliding  
полное выдвижение

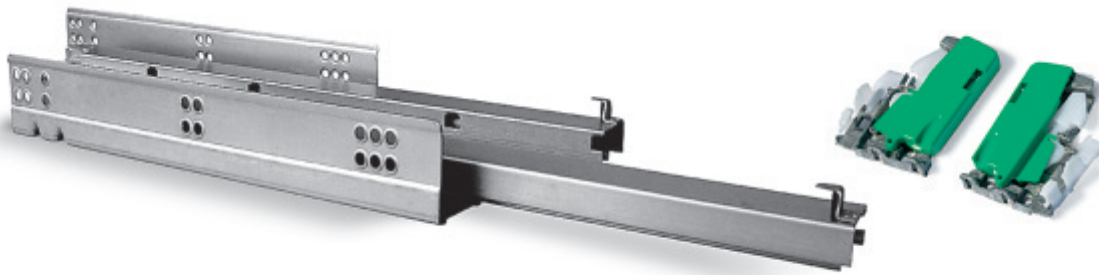

## Cechy produktu / Features / Характеристика товара:

- kompaktowy design (prowadnica niemal niewidoczna) / compact design (guide almost invisible) компактный дизайн (направляющая почти незаметна)
- obciążenie dynamiczne do 30 kg / dynamic load up to 30 kg / динамическая нагрузка до 30 кг
- mechanizm samodociągu z funkcją cichego domytku / auto-drawing-up mechanism with quiet shut function  
механизм самодоката с функцией бесшумного доката
- opcja reset / reset option / возможность ресета
- łatwy montaż, możliwość regulacji frontu szuflady / easy mounting, drawer front adjustment possibility / легкая установка, возможность регулировки фронта ящика
- dostępna w wersji z pełnym wysuwem i 3/4 wysuwu / available in full sliding and 3/4 sliding version / доступна версия с полным выдвижением и 3/4 выдвижения

## Montaż prowadnic do szuflad drewnianych / Guide mounting - Монтаж направляющей

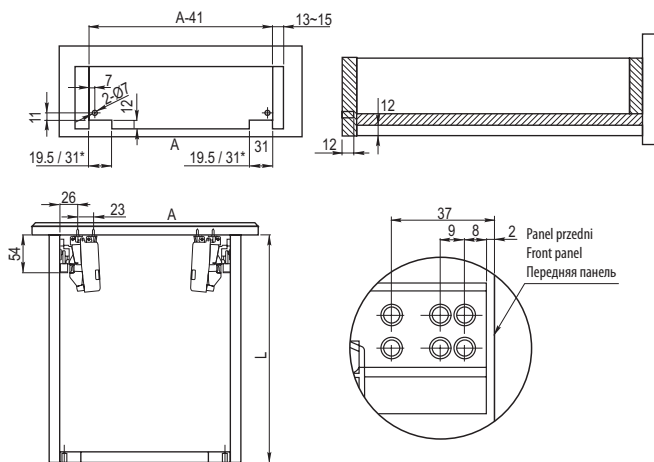

## Schemat montażu / Mounting scheme / Схема монтажа

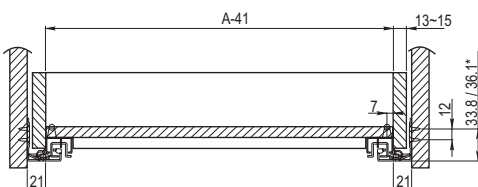

stal / steel / сталь

material



L=300, 350, 400, 450, 500, 550

size

## Rozstaw otworów w szufladach / Hole spacing in drawers Размещение отверстий в ящиках

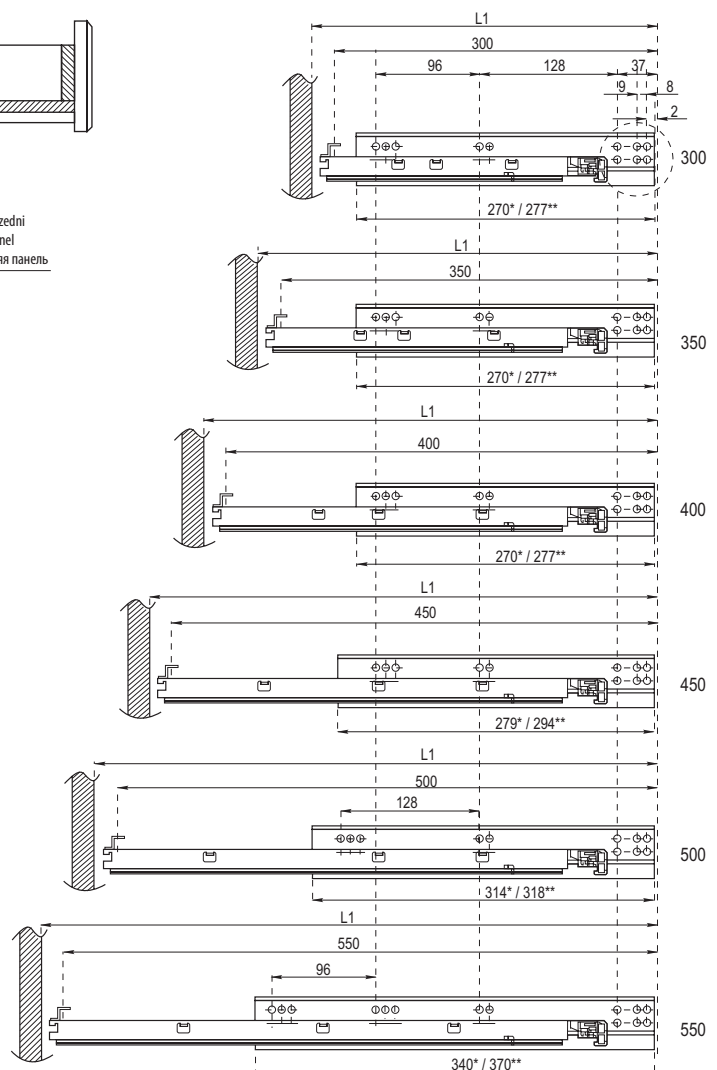

# Prowadnice rolkowe

Euro slides / Роликовые направляющие

Index: PR-SP-...-... (L) (color)    PR-SX-...-... (L) (color)    PR-OB-...-... (L) (color)



### Cechy produktu / Features / Характеристика товара:

- dostępne trzy wersje: SP – Prestige, SX – Standard, OB – Economic / three versions available: SP – Prestige, SX – Standard, OB – Economic  
доступны три варианта: SP - Престиж, SX - Стандарт, OB - Экономический
- dopuszczalne obciążenie: SP - 25 kg, SX i OB - 20 kg / allowable load: SP - 25 kg, SX i OB - 20 kg / допустимая нагрузка 35 кг: SP - 25 кг, SX i OB - 20 кг
- materiał: SP i SX – stal + rolka POM, OB – stal + rolka ABS / material: SP and SX – steel + roll POM, OB – steel + roll ABS  
материал: SP, SX - сталь + ролик POM, OB - сталь + ролик ABS

### Schemat prowadnicy szuflady dla L=250 mm / Drawer guide scheme for L=250 mm Схема направляющей ящика для L=250 мм

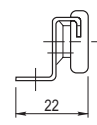
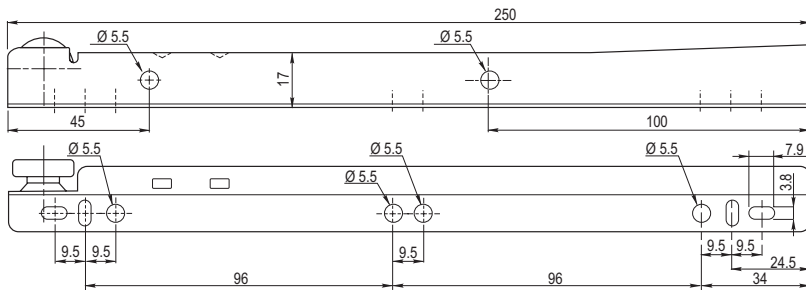

Minimalna wysokość korpusu  
Minimum height of body  
Минимальная высота корпуса

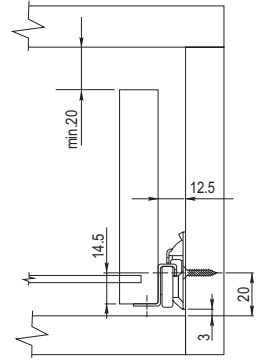

### Schemat prowadnicy korpusu dla L=250 mm / Body guide scheme for L=250 mm Схема направляющей корпуса для L=250 мм

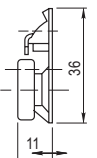
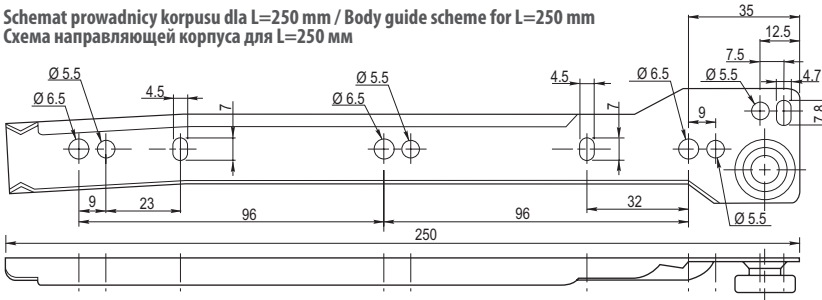

### Głębokość wysuwu / Sliding depth / Глубина выдвигания

L	SW	DW
250 mm	87	162
300 mm	87	212
350 mm	87	262
400 mm	87	312
450 mm	97	352
500 mm	97	402
550 mm	117	432
600 mm	117	482

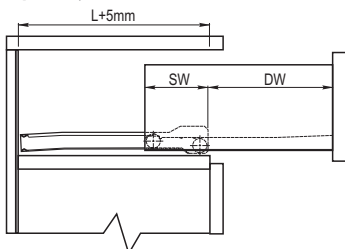

L - Długość prowadnicy / Guide length / Длина направляющей  
SW - Strata długości wysuwu / Sliding length loss / Потеря длины выдвигания  
DW - Rzeczywista długość wysuwu / Real sliding length / Действительная длина выдвигания

### Pozycja mocowania prowadnic korpusu Fixing position of body guides Место крепления направляющих корпуса

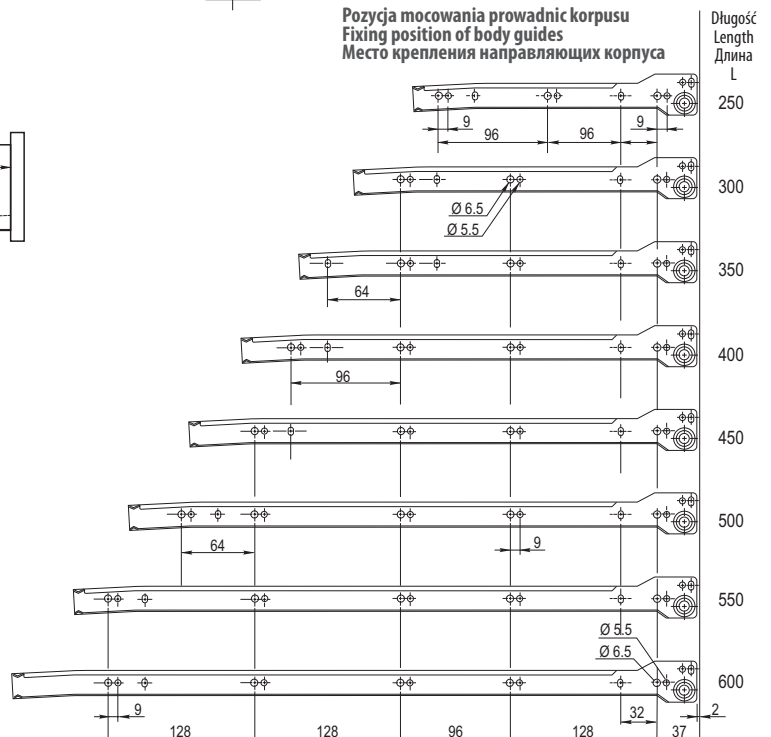

stal + POM



L = 250, 300, 350, 400, 450, 500, 550, 600

# Spowalnicz do prowadnic rolkowych

Index: AM-PRSOFT-00

Soft closing device for euro slides / Механизм замедления для роликовых направляющих



## Cechy produktu / Features / Характеристика товара:

- uniwersalność montażu: prawy i/lub lewy bok / mounting universality: right and/or left side  
универсальность монтажа: правая и/или левая сторона
- mechanizm gazowy spowalnicza / gas mechanism of retarder / газовый механизм механизма замедления
- miękki domyk / soft shut / мягкий докат
- do szuflad drewnianych / for wooden drawers / для деревянных ящиков
- przestrzeń montażowa 10 mm – 13.5 mm / mounting space 10 mm – 13.5 mm / монтажное пространство 10 мм - 13.5 мм
- brak opcji „reset” / lack of “reset” option / без функции “ресет”
- do prowadnic rolkowych i kulowych po demontażu gumowego hamulca / for roll and ball guides after dismantling rubber brake  
для роликовых и шариковых направляющих после разборки резинового тормоза

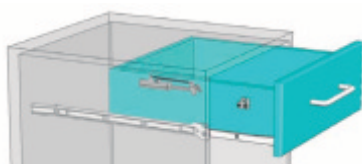
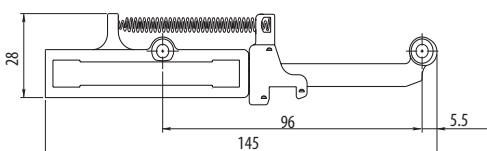

Zawartość opakowania / Including  
Содержание упаковки

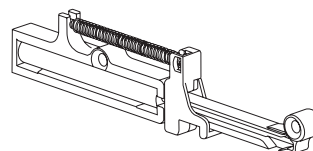

1. Spowalnicz / Soft closing device  
Механизм замедления



2. Zaczep / Follower / Зацеп

## Schemat montażu / Application / Монтаж

1. Zaznacz linię odniesienia / Mark reference line  
Обозначить базовую линию

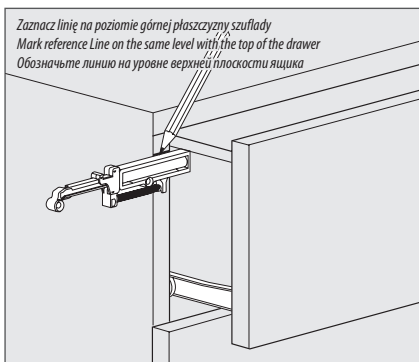

2. Zaznacz lokalizację otworów / Mark hole locations  
Обозначить размещение отверстий

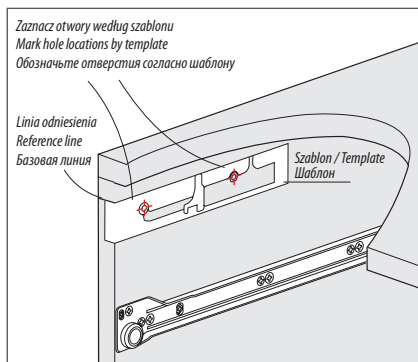

3. Zamocuj spowalnicz do szafki / attach the body to cabinet  
Монтаж механизма замедления в шкафу

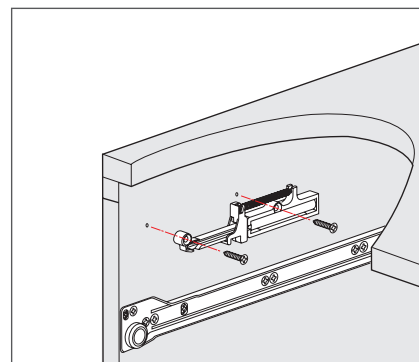

4. Zaznacz lokalizację otworów / Mark hole locations  
Обозначить размещение отверстий

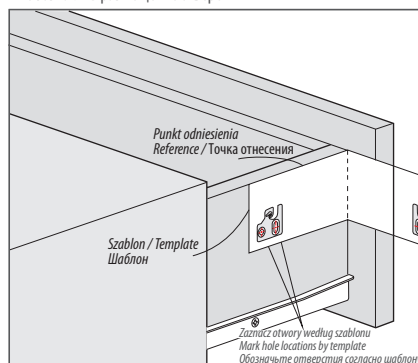

5. Zamocuj zaczep do szuflady / Attach the „Follower” to drawer  
Монтаж зацепа в ящике

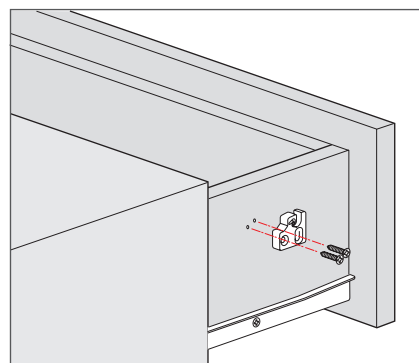

plastik / plastic / пластмасса

# Metalbox

Metalbox / Металбок

Index: MP-.....-..  
(H+L) (color)



### Cechy produktu / Features / Характеристика товара:

- dopuszczalne obciążenie 25 kg / allowable load 25 kg / допустимая нагрузка 25 кг

Schemat szuflady metalbox o długości 270 mm i wysokości 86 mm  
Scheme of 270 mm-long and 86 mm-high metalbox drawer  
Схема ящика металбокса длиной в 270 мм и высотой в 86 мм

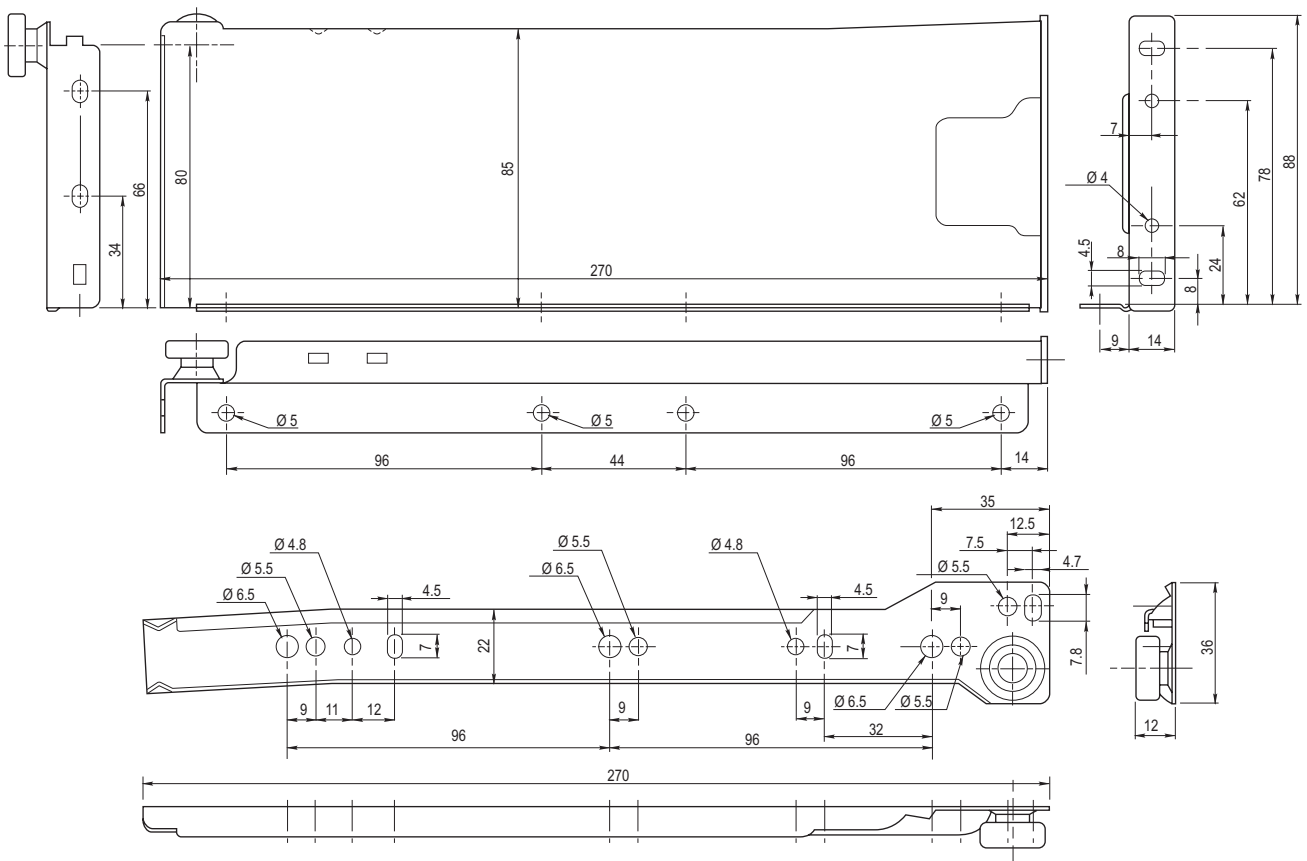

stal / steel / сталь



H= 54, 86, 118, 150  
L= 250, 300, 350, 400, 450, 500, 550, 600

**Regulacja wysokości frontu / Front height adjustment**  
**Регулировка высоты фронтальной панели**

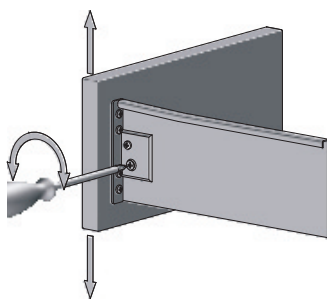

**Wymiary elementów płytowych dla płyty o grubości 18 mm**  
**Dimensions of board elements for 18mm-thick board**  
**Размеры элементов панели толщиной в 18 мм**

L - Długość prowadnicy / Guide length  
 Длина направляющей  
 LW - Szerokość wewnętrzna korpusu  
 Body internal width  
 Внутренняя ширина корпуса

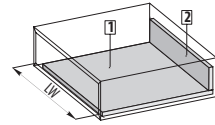

Oznaczenie Marking Обозначение	Nazwa Name Наименование	Długość/wysokość w mm Length / height in mm Длина/высота в мм	Szerokość w mm Width in mm Ширина в мм
1	Dno szuflady Bottom panel Днище ящика	L-2	LW-31
2	Ścianka tylna szuflady Drawer back wall Задняя панель ящика	61	LW-32

**Głębokość wysuwu / Sliding depth**  
**Глубина выдвигания**

L	SW	DW
270	87	182
300	87	212
350	87	262
400	87	312
450	97	352
500	97	402
550	117	432

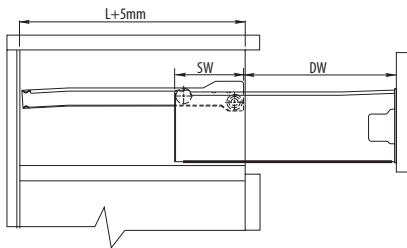

L - Długość prowadnicy / Guide length / Длина направляющей  
 SW - Strata długości wysuwu / Sliding length loss / Потеря длины выдвигания  
 DW - Rzeczywista długość wysuwu / Real sliding length / Действительная длина выдвигания

**Pozycja mocowania prowadnic korpusu**  
**Fixing position of body guides**  
**Место крепления направляющих корпуса**

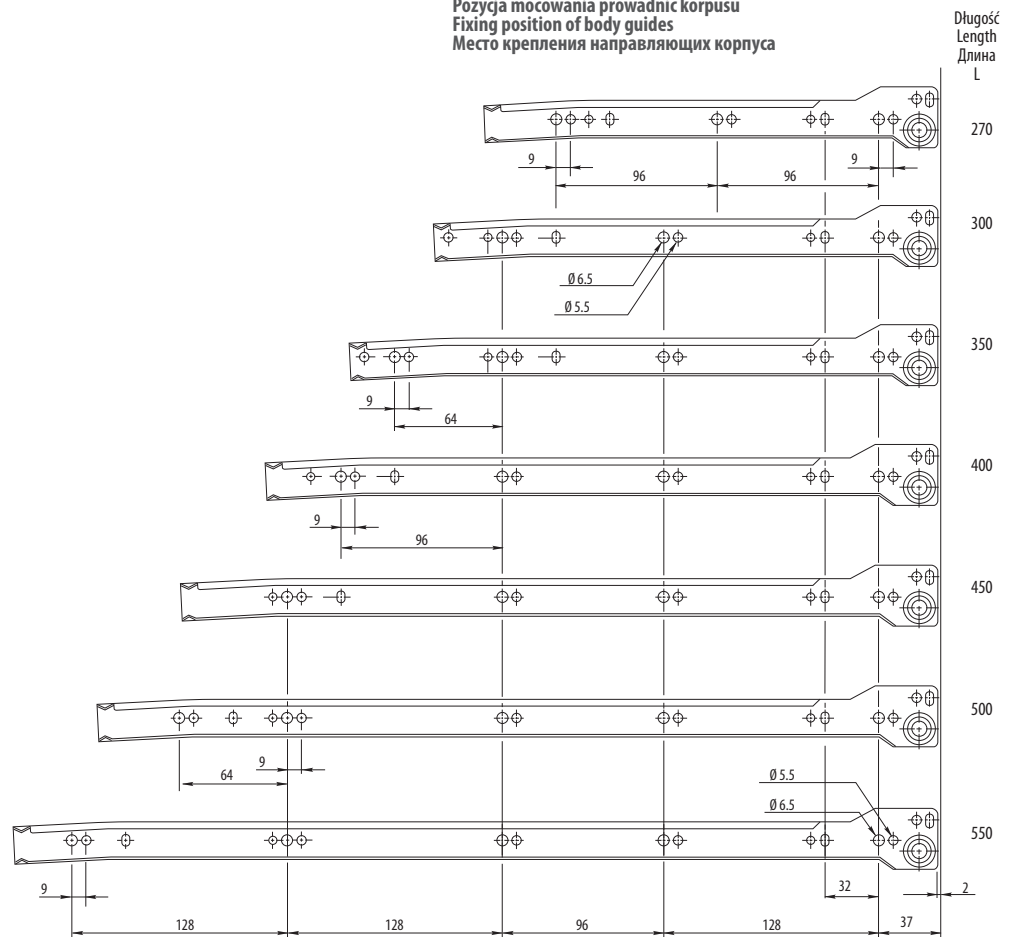

MP-54

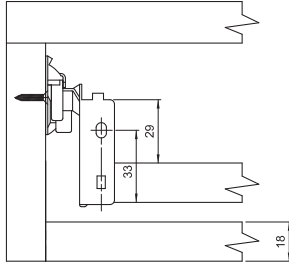

Wymiary montażowe ścianki tylnej  
Back wall mounting dimensions  
Монтажные размеры задней панели

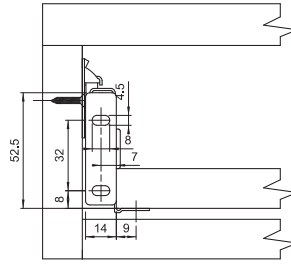

Wymiary montażowe frontów  
Mounting dimensions of fronts  
Монтажные размеры фронтальных панелей

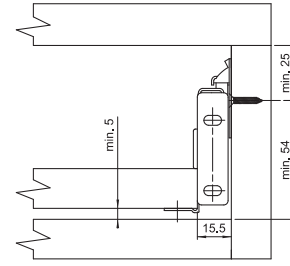

MP-86

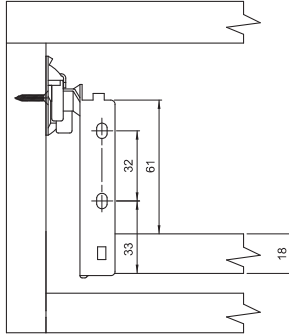

Wymiary montażowe ścianki tylnej  
Back wall mounting dimensions  
Монтажные размеры задней панели

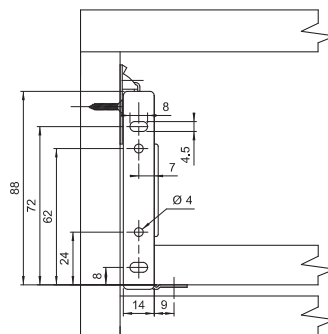

Wymiary montażowe frontów  
Mounting dimensions of fronts  
Монтажные размеры фронтальных панелей

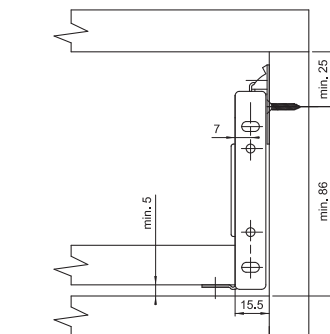

MP-118

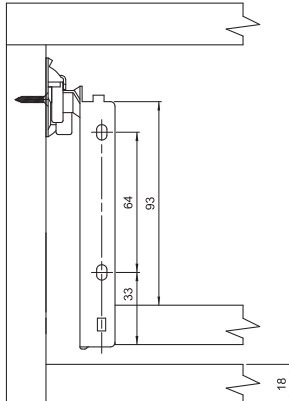

Wymiary montażowe ścianki tylnej  
Back wall mounting dimensions  
Монтажные размеры задней панели

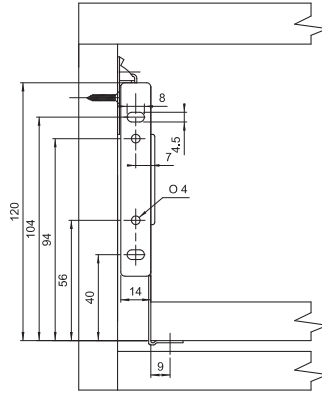

Wymiary montażowe frontów  
Mounting dimensions of fronts  
Монтажные размеры фронтальных панелей

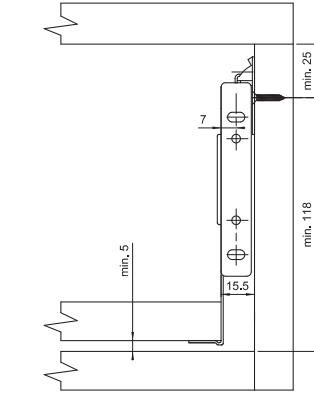

MP-150

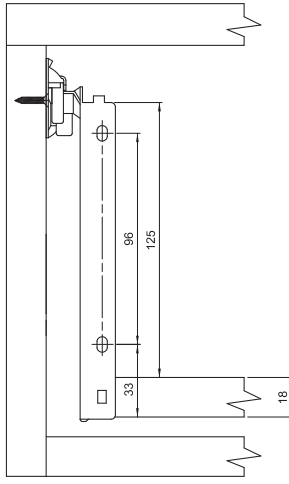

Wymiary montażowe ścianki tylnej  
Back wall mounting dimensions  
Монтажные размеры задней панели

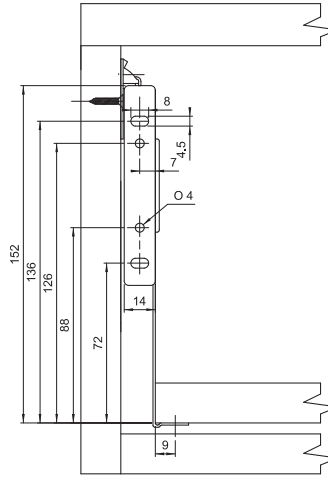

Wymiary montażowe frontów  
Mounting dimensions of fronts  
Монтажные размеры фронтальных панелей

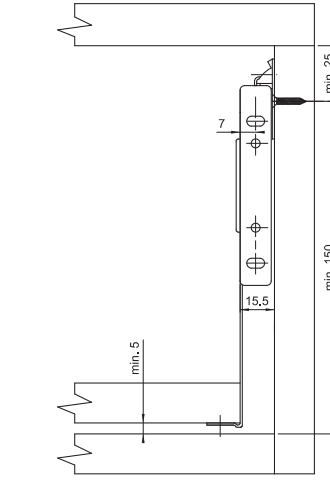

# Spowalnicz do metalboksów

Index: AM-MBSOFT-00

Soft closing device for metalbox / Механизм замедления для стальных направляющих (металбокс)



## Cechy produktu / Features / Характеристика товара:

- uniwersalność montażu: prawy i/lub lewy bok / mounting universality: right and/or left side  
универсальность монтажа: правая и/или левая сторона
- mechanizm gazowy spowalnicza / gas mechanism of retarder / газовый механизм механизма замедления
- miękki domyk / soft shut / мягкий докат
- do szuflad drewnianych / for wooden drawers / для деревянных ящиков
- przestrzeń montażowa 15.5 mm / mounting space 15.5 mm / монтажное пространство 15.5 мм
- brak opcji „reset” / lack of “reset” option / без функции “ресет”
- do prowadnic metalbox / for metalbox guides / для металбоксов
- łatwy sposób montażu / easy mounting method / легкая установка

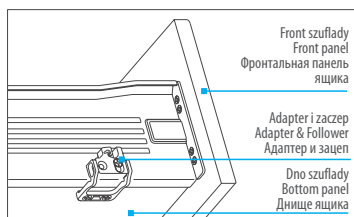
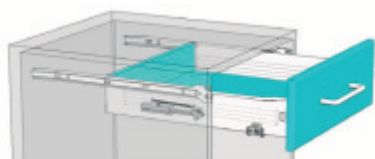
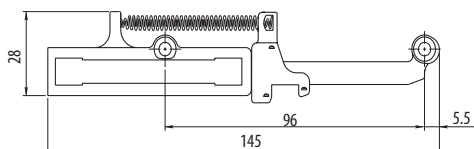

Zawartość opakowania / Including  
Содержание упаковки

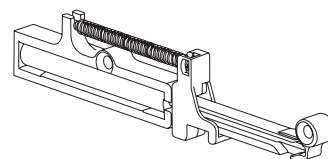

1. Spowalnicz / Soft closing device  
Механизм замедления



2. Zaczer / Follower / Зацеп



3. Adapter / Адаптер

## Schemat montażu / Application / Монтаж

1. Zaznacz linię odniesienia / Mark reference line  
Обозначить базовую линию

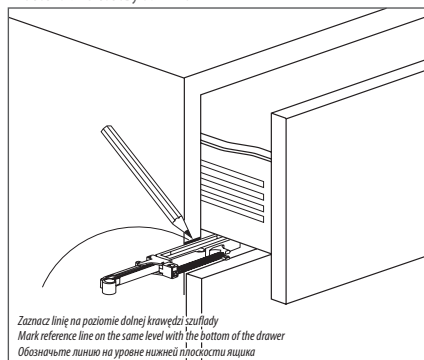

2. Zaznacz lokalizację otworów / Mark hole locations  
Обозначить размещение отверстий

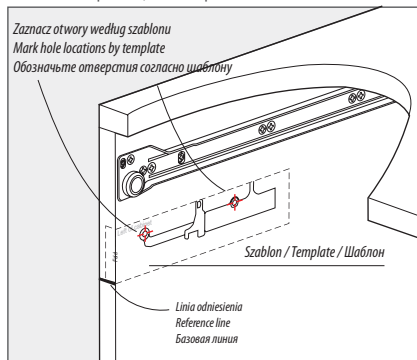

3. Zamocuj spowalnicz do szafki / Attach the body to cabinet  
Монтаж механизма замедления в шкафу

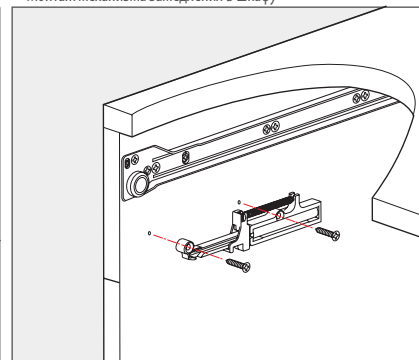

4. Zaznacz lokalizację otworów / Mark hole locations  
Обозначить размещение отверстий

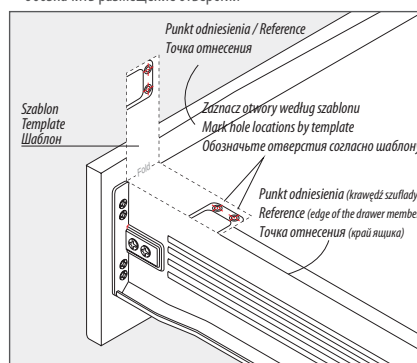

5. Zamocuj adapter do szuflady / Attach the adapter to drawer  
Монтаж адаптера в ящике

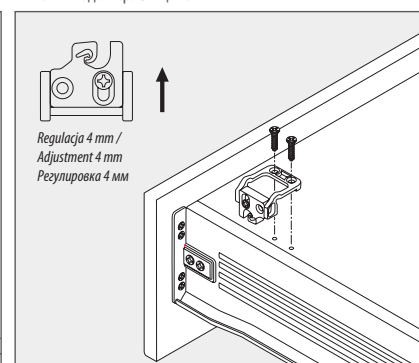

plastik / plastic / пластмасса



# MB

## MODERN BOX

### Gwarantowana jakość na lata

ModernBox to całkowita nowość i zarazem jeden z najnowocześniejszych systemów szuflad wprowadzonych na polski rynek. Jego jakość potwierdzają certyfikaty wystawiane przez renomowane, międzynarodowe ośrodki badań, w tym SGS. Debiut produktu m.in. na rygorystycznym rynku Wysp Brytyjskich umożliwiło uzyskanie certyfikatu FIRA. ModernBox to jednak nie tylko zaawansowana technologia gwarantująca jakość i wytrzymałość. To także codzienny komfort, uniwersalna funkcjonalność i nowoczesny design, sprawiające, że ModernBox to idealne rozwiązanie dla każdego domu.

### Guaranteed quality for years

ModernBox is a radically new concept and one of the most modern systems of drawers introduced in the Polish market. Its quality is confirmed by certificates issued by reputable, international research centers, including SGS. The Product debut, among other in the rigorous market of the British Isles made possible to obtain the FIRA certificate. ModernBox is not only advanced technology guaranteeing the quality and durability. It is also a daily comfort, versatile functionality and modern design causing that ModernBox is an ideal solution for any home.

### Гарантированное многолетнее качество

Modern Box – это новинка и одновременно одна из самых современных систем ящиков, появившихся на польском рынке. Ее качество подтверждают сертификаты, выставленные международными исследовательскими центрами. Успех продукта, в том числе на консервативном рынке Великобритании, позволил получить сертификат FIRA. Однако, Modern Box – это не только совершенная технология, гарантирующая качество и прочность. Это также удобство использования, универсальная функциональность и современный дизайн, поэтому Modern Box является идеальным решением для каждого дома.

### Cechy produktu / Features / Характеристика товара:

- Pełny wysuw / Full sliding / Полное выдвижение
- Obciążenie do 40 kg / Load up to 40 kg / Нагрузка до 40 кг
- Cichy domyk / Quiet shut / Бесшумное закрывание
- Pełna regulacja (pion i poziom) / Full adjustment (vertically and horizontally) / Полная регулировка (по диагонали и вертикали)



material

stal / steel / сталь



color



L= 350, 400, 450, 500, 550



size

### Aksesoria do systemu Modern Box / Accessories for Modern Box system / Аксессуары для системы ModernBox

- ReLING podłużny / Longitudinal riling / Продольный релинг 1100mm
- ReLING poprzeczny / Transverse riling / Поперечный релинг 1100mm
- Łącznik relingu / Riling connector / Соединитель релинга
- Łącznik relingu poprzecznego / Transverse riling connector / Соединитель поперечного релинга



**Wymiary montażowe dla szuflady niskiej / Mounting dimensions for low drawer / Монтажные размеры для низкого ящика**

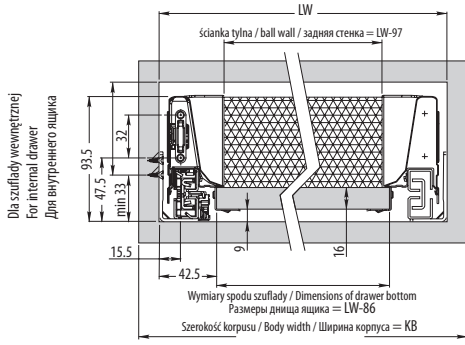

Wymiary montażowe mocowania tyłu  
Mounting dimensions of back fixing  
Монтажные размеры крепления задней части

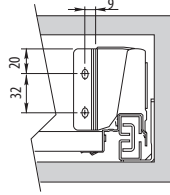

Wymiary montażowe frontu  
Mounting dimensions of front  
Монтажные размеры фасада

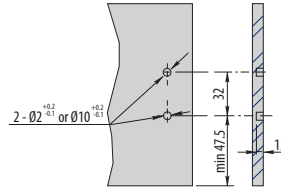

**Wymiary montażowe dla szuflady średniej / Mounting dimensions for medium drawer / Монтажные размеры для среднего ящика**

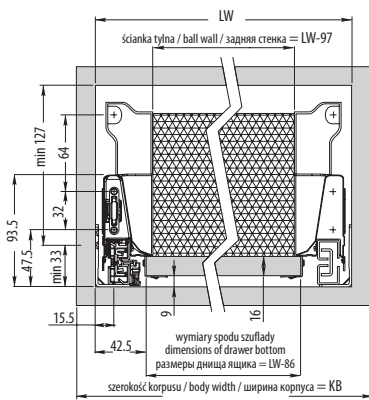

Wymiary montażowe mocowania tyłu  
Mounting dimensions of back fixing  
Монтажные размеры крепления задней части

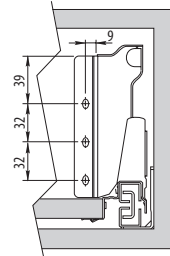

Wymiary montażowe frontu  
Mounting dimensions of front  
Монтажные размеры фасада

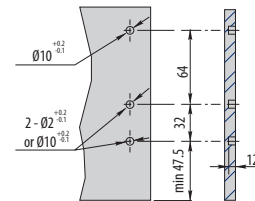

**Wymiary montażowe dla szuflady wysokiej / Mounting dimensions for high drawer / Монтажные размеры для высокого ящика**

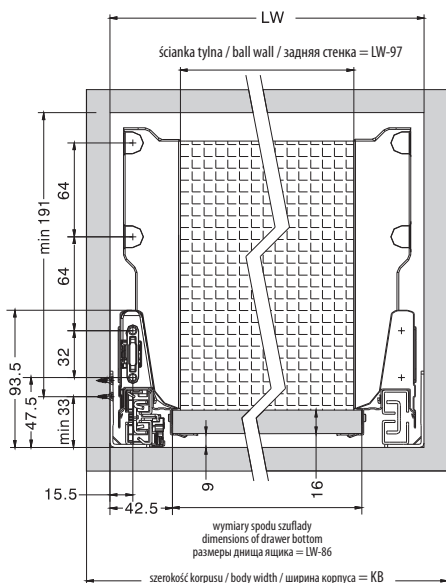

Wymiary montażowe mocowania tyłu  
Mounting dimensions of back fixing  
Монтажные размеры крепления задней части

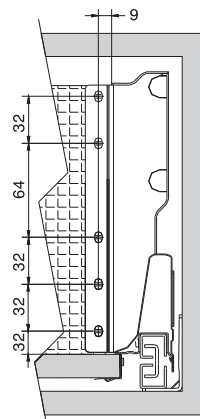

Wymiary montażowe frontu  
Mounting dimensions of front  
Монтажные размеры фасада

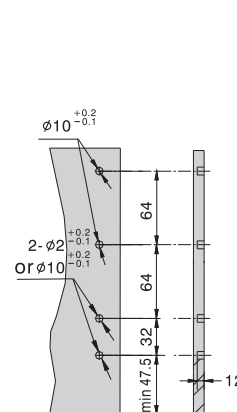

**Wymiary montażowe tyłu i spodu szuflady dla płyty 16 mm / Mounting dimensions of drawer back and bottom for 16 mm board**  
**Монтажные размеры задней части и дна ящика для плиты 16 мм**

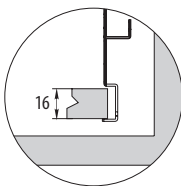
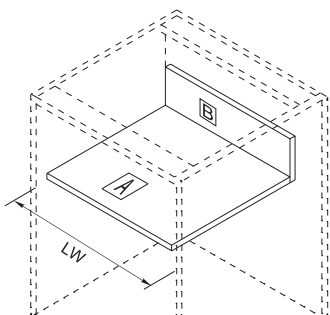

L Długość nominalna / Nominal length / Номинальная длина  
 LW Wewnętrzna szerokość korpusu / Body internal width / Внутренняя ширина корпуса

**Wymiary ścianki tylnej / Back wall dimensions / Размеры задней стенки:**

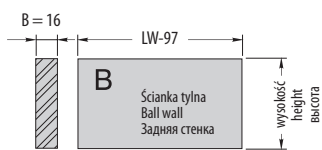

Szuflada niska: wysokość = 84 mm  
 Szuflada średnia: wysokość = 135 mm  
 Szuflada wysoka: wysokość = 199 mm  
 Lower Drawer: height = 84 mm  
 Medium Drawer: height = 135 mm  
 High Drawer: height = 199 mm  
 Маленький ящик: высота = 84 мм  
 Средний ящик: высота = 135 мм  
 Большой ящик: высота = 199 мм

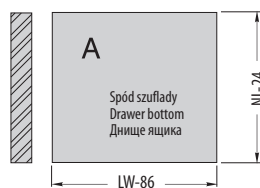

**Propozycje mocowania przewodnic / Guides fixing proposals / Примеры установки направляющих**

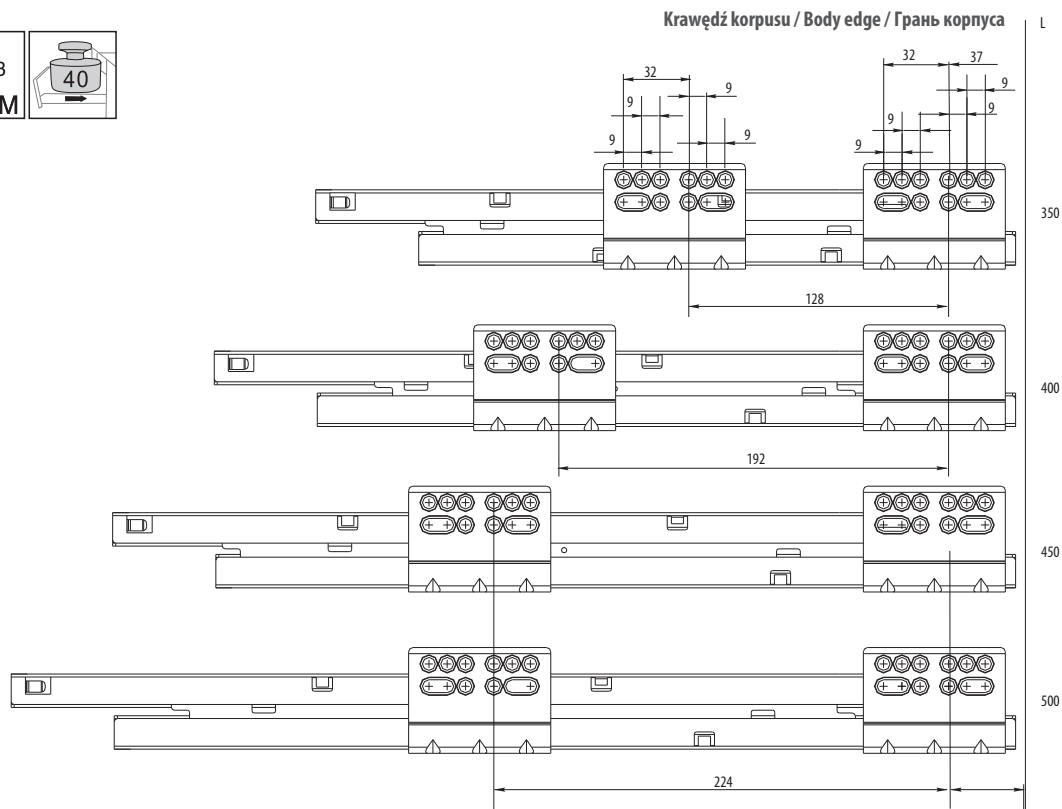
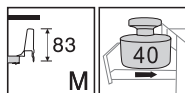

## Schemat montażu / Application / Монтаж

1. Przy pomocy wkrętów połącz mocowanie ze ścianką tylną  
Fit back Fixing-brackets with screwdriver  
Соедините винтами крепление и заднюю стенку

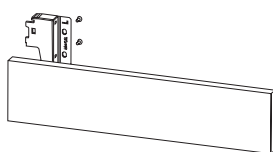

2. Połącz boki szuflady z jej tyłem  
Assemble back to sides  
Соедините боковины ящика с его задней стенкой

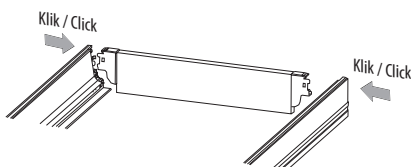

3. Wsuń spód szuflady  
Slide wood bottom into position  
Вставьте дно ящика

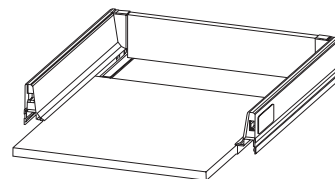

4. Przykręć mocowanie frontu do panelu przedniego  
Fit front fixing brackets. Assemble front to sides  
Прикрутите фронтальное крепление к передней панели

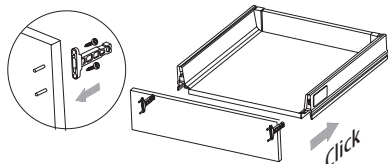

5. Skręć spód szuflady z bokami  
Drill holes and fix screws on the bottom  
Скрутите дно ящика с его боками

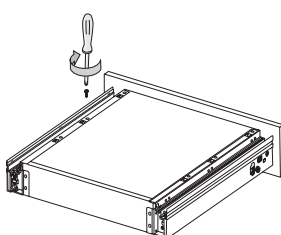

6. Załóż plastikowe zaślepki  
Fit coser caps  
Вставьте пластиковые заглушки

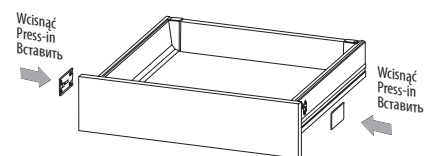

## Montaż frontu szuflady i relingów / Installation of wood drawer front and side rails / Монтаж фронта ящика с релингами

1

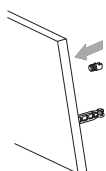

2

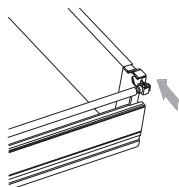

3

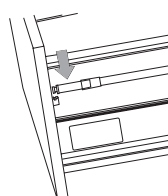

## Regulacja / Adjustment / Регуляция

1

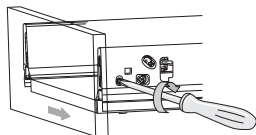

2

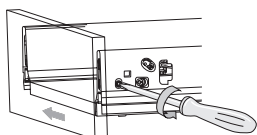

3

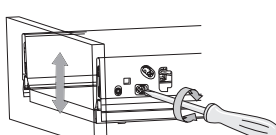

4

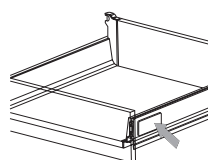

5

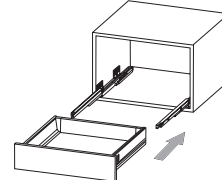

1

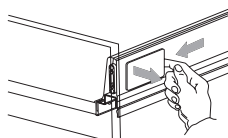

2

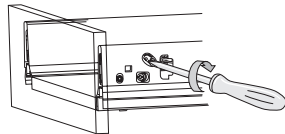

3

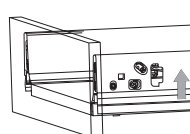

4

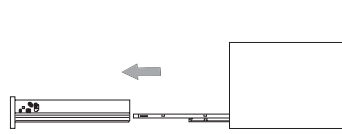

Demontaż frontu / Release the drawer front / Демонтаж фронта

Demontaż szuflady / Release drawer from the slide / Разборка ящика

Index	Strona / Page / Страница
AM-MBSOFT-00	13
AM-PRSOFT-00	9
MP-.....-..	10
PB-D-KPL...A	14
PB-D-KPL...B	14
PB-D-KPL...C	14
PB-DOL...-00	7
PB-DRW...-00	7
PK-O-H17-...	1
PK-0H35-...0	2
PK-O-H45-...	3
PK-0H45...XP	4
PK-S-H-45...	5
PK-SPH45...0	6
PR-OB-...-..	8
PR-SP-...-..	8
PR-SX-...-..	8

**Pokrycia galwaniczne / Galvanic coatings**  
**Шаблон гальванических покрытий**

- 01  chrom / chrome / хром
- 02  satyna / satin / сатин
- 03  mosiądz / brass / золото
- 04  stary mosiądz / antique brass / старое золото
- 05  aluminium / алюминий
- 06  stal szcztokowana / brushed steel / шлифованная сталь

**Pokrycia lakiernicze / Enamel coatings**  
**Шаблон лакированных покрытий**

- 10  biały / white / белый
- 20  czarny / black / чёрный

WWW.GTV.COM.PL

**GTV**

*ul. Przejazdowa 21  
05-800 Pruszków  
Poland*

*tel. + 48 22 444 75 00  
fax + 48 22 444 75 01  
mail: [info@werkpol.pl](mailto:info@werkpol.pl)*

*[www.gtv.com.pl](http://www.gtv.com.pl)*



***Uchwyty • Wieszaki • Nóżki meblowe  
Handles • Hooks • Furniture legs  
Ручки • Вешалки • Мебельные ножки***

## Uchwyt B224

Handle B224 / Ручка B224

Index: UZ-00B224-..  
(color)

### Cechy produktu / Features Характеристика товара:

- uchwyt wpuszczany / sunk handle / врезная ручка

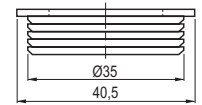
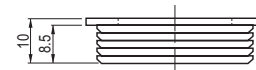
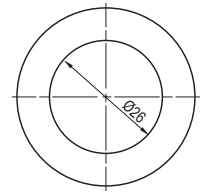

ZnAl

material



color



## Uchwyt B226

Handle B226 / Ручка B226

Index: UZ-00B226-..  
(color)

### Cechy produktu / Features Характеристика товара:

- uchwyt wpuszczany / sunk handle / врезная ручка

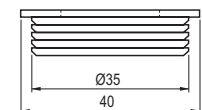
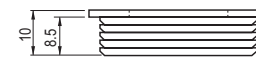
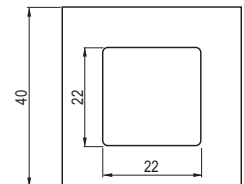

ZnAl

material



color



## Uchwyt UA-114

Handle UA-114 / Ручка UA-114

Index: UA-AA-114-..  
(color)

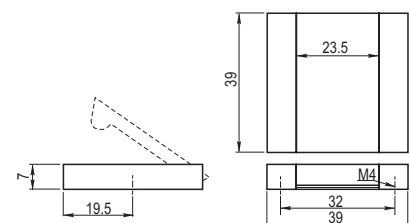
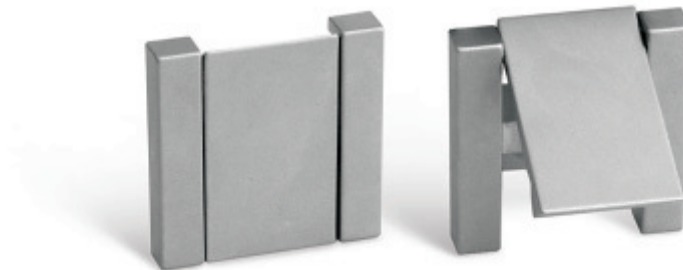

ZnAl

material



color



## Uchwyt UZ-01

Handle UZ-01 / Ручка UZ-01

Index: UZ-01-...-...  
(C) (color)



ZnAl

material



color



size

C 96 128  
L 121 164

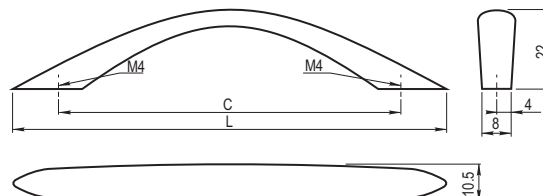

## Uchwyt UZ-04

Handle UZ-04 / Ручка UZ-04

Index: UZ-04-...-...  
(C) (color)



ZnAl

material



color



128

96

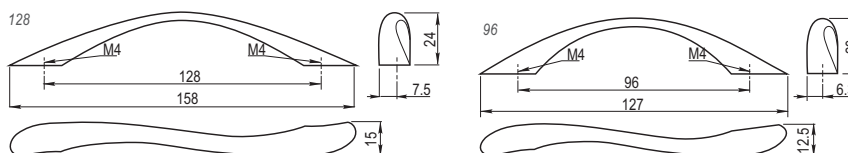

## Uchwyt UZ-05

Handle UZ-05 / Ручка UZ-05

Index: UZ-05-...-...  
(C) (color)



details



ZnAl

material



color



size

C 96 128  
L 132 164

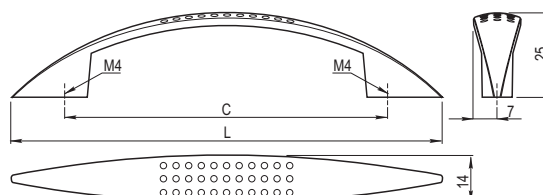

## Uchwyt UZ-06

Handle UZ-06 / Ручка UZ-06

Index: UZ-06-128-...  
(color)



ZnAl

material



color

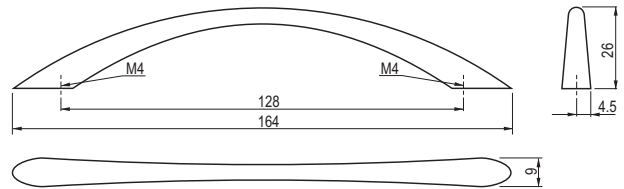

## Uchwyt UZ-07

Handle UZ-07 / Ручка UZ-07

Index: UZ-07-096-...  
(color)



ZnAl

material



color

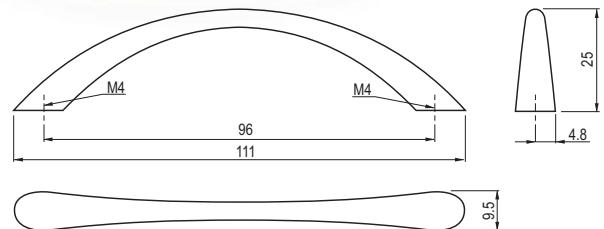

## Uchwyt UZ-10

Handle UZ-10 / Ручка UZ-10

Index: UZ-10-096-N04



details



ZnAl

material



color

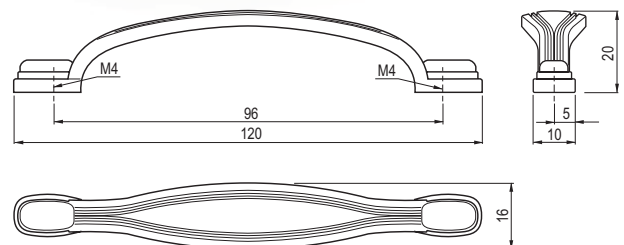

## Uchwyt UZ-13

Handle UZ-13 / Ручка UZ-13

Index: UZ-13-096-...  
(color)



ZnAl

material



color

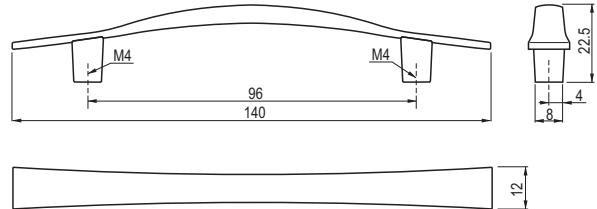

## Uchwyt UZ-14

Handle UZ-14 / Ручка UZ-14

Index: UZ-14-...-...  
(C) (color)



details



ZnAl

material



color



size

C 96 128

L 124 164

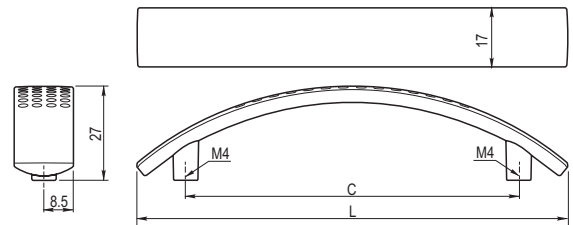

## Uchwyt UZ-19

Handle UZ-19 / Ручка UZ-19

Index: UZ-19-032-...  
(color)

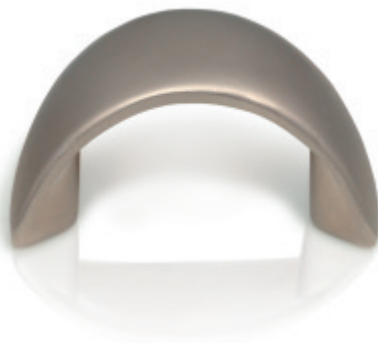

ZnAl

material



color

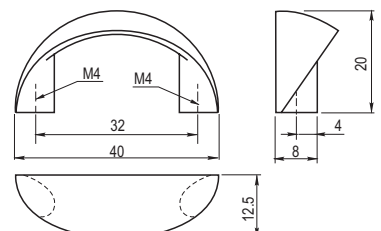

## Uchwyt UZ-40

Handle UZ-40 / Ручка UZ-40

Index: UZ-40-032-..  
(color)

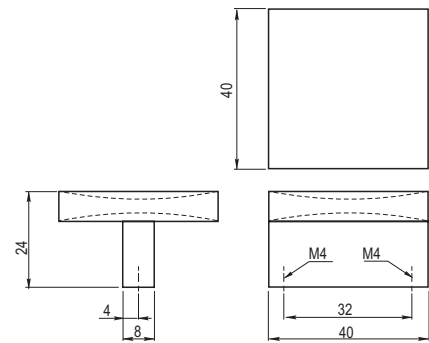
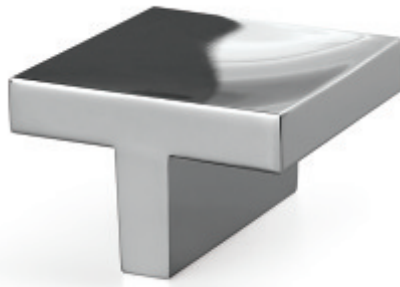

ZnAl



## Uchwyt UZ-55

Handle UZ-55 / Ручка UZ-55

Index: UZ-55-025-..  
(color)

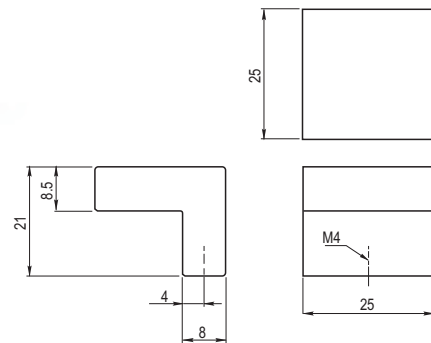

ZnAl



## Uchwyt UZ-60

Handle UZ-60 / Ручка UZ-60

Index: UZ-60-032-..  
(color)

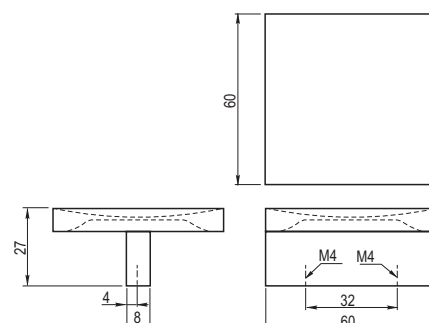

ZnAl



## Uchwyt UZ-64F

Handle UZ-64F / Ручка UZ-64F

Index: UZ-64F...-01  
(C)



ZnAl

material



color



size

C1/C2	160/192	256/288
L	262	358

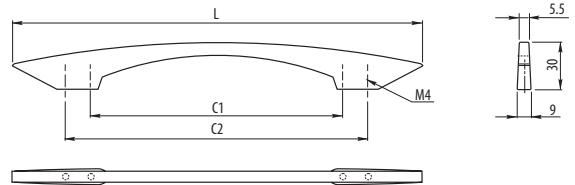

## Uchwyt UZ-71

Handle UZ-71 / Ручка UZ-71

Index: UZ-71-...-...  
(C) (color)



ZnAl

material



color



size

C	96	128
L	108	140

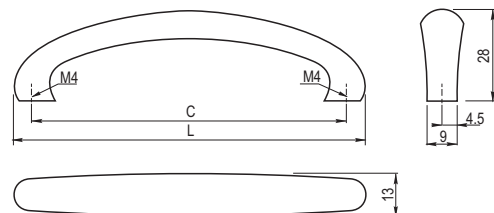

## Uchwyt UZ-92

Handle UZ-92 / Ручка UZ-92

Index: UZ-92-...-...  
(C) (color)



ZnAl

material



color



size

C	128	160
L	135	167

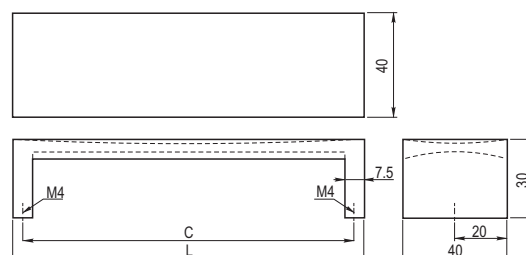

## Uchwyt UZ-334

Handle UZ-334 / Ручка UZ-334

Index: UZ-334...-06  
(C)



ZnAl



color



size

C 128 160 192 256  
L 144 175 206 272

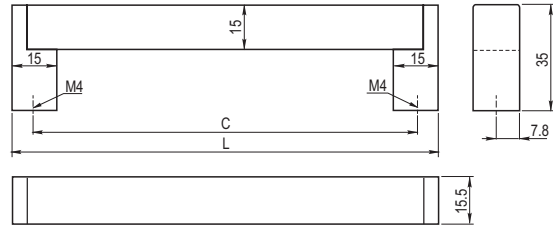

## Uchwyt UZ-335

Handle UZ-335 / Ручка UZ-335

Index: UZ-335...-06  
(C)



ZnAl



color



size

C 128 160 192 256  
L 137 169 212 265

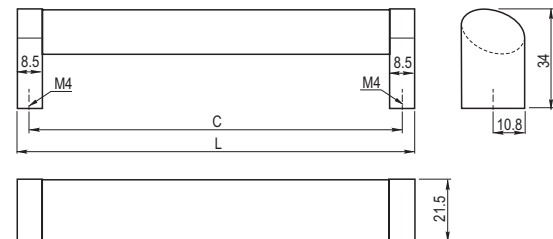

## Uchwyt UZ-336

Handle UZ-336 / Ручка UZ-336

Index: UZ-336...-06  
(C)



ZnAl



color



size

C 128 160 192 256 320 416 480  
L 137 169 212 265 329 425 489

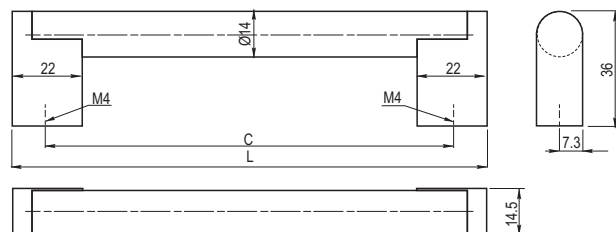

## Uchwyt UZ-605

Handle UZ-605 / Ручка UZ-605

Index: UZ-605032-...  
(color)

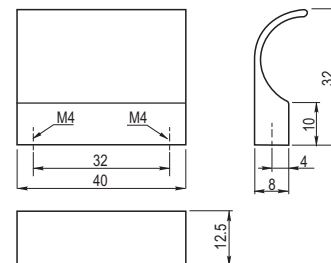
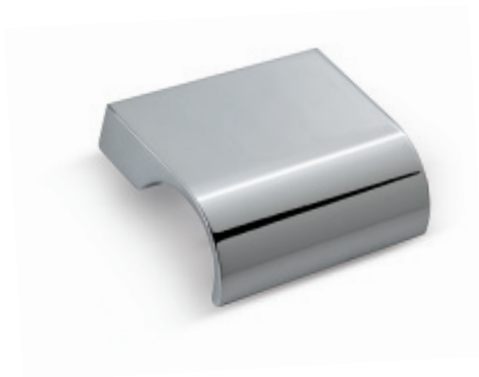

ZnAl

material



color



## Uchwyt UZ-682

Handle UZ-682 / Ручка UZ-682

Index: UZ-682...-06  
(C)

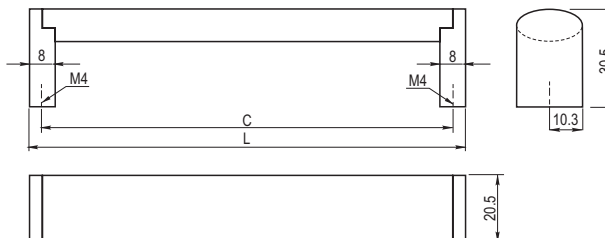

ZnAl

material



color



size

C	128	160	192	256	320	416	480
L	136	170	209	266	329	425	489

## Uchwyt UZ-752

Handle UZ-752 / Ручка UZ-752

Index: UZ-752...-06  
(C)

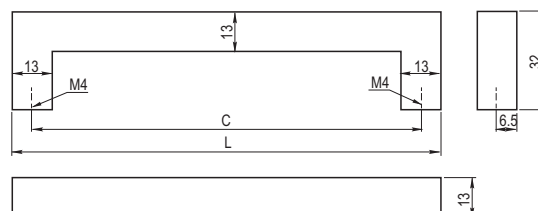

ZnAl

material



color



size

C	128	160	192	256
L	143	175	207	271

## Uchwyt UZ-804

Handle UZ-804 / Ручка UZ-804

Index: UZ-804064-...  
(color)

### Cechy produktu / Features / Характеристика товара:

- uchwyt można wykorzystać jako wieszak  
handle can be used as a hanger  
ручку можно использовать в качестве вешалки

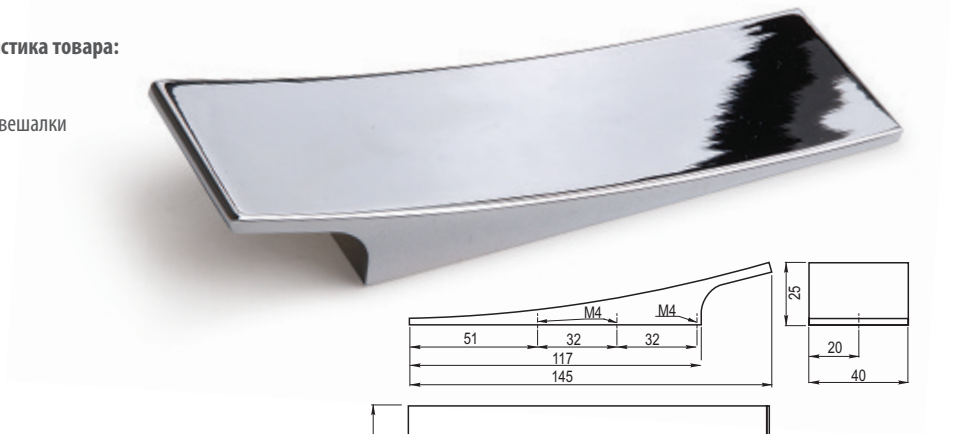

ZnAl

material



color



## Uchwyt UZ-814

Handle UZ-814 / Ручка UZ-814

Index: UZ-814...-...  
(C) (color)

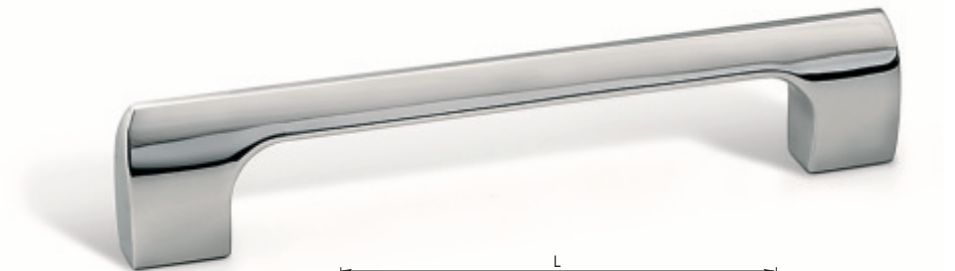

ZnAl

material



color



size

C 128 256  
L 146 274

## Uchwyt UZ-819

Handle UZ-819 / Ручка UZ-819

Index: UZ-819...-...  
(C) (color)

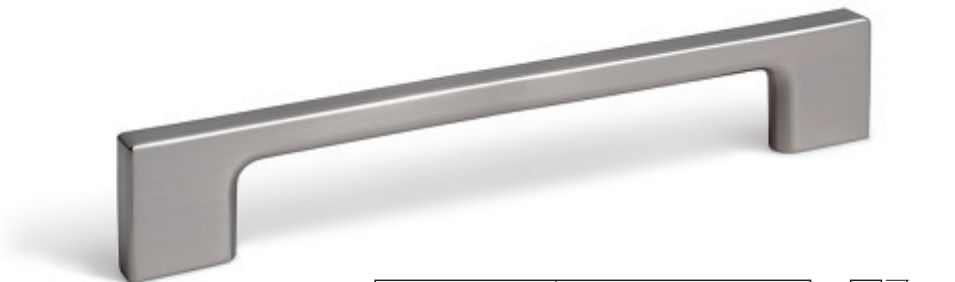

ZnAl

material



color



size

C 96 128 160 192 256 320  
L 128 160 192 224 288 352

## Uchwyt UZ-870

Handle UZ-870 / Ручка UZ-870

Index: UZ-870...-..  
(C) (color)

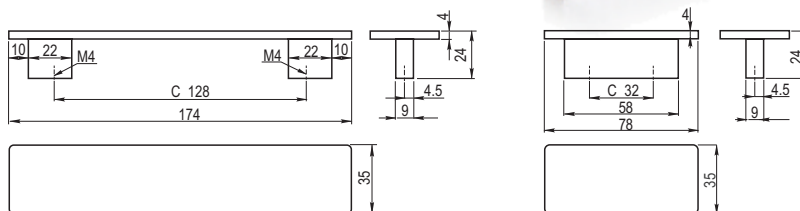
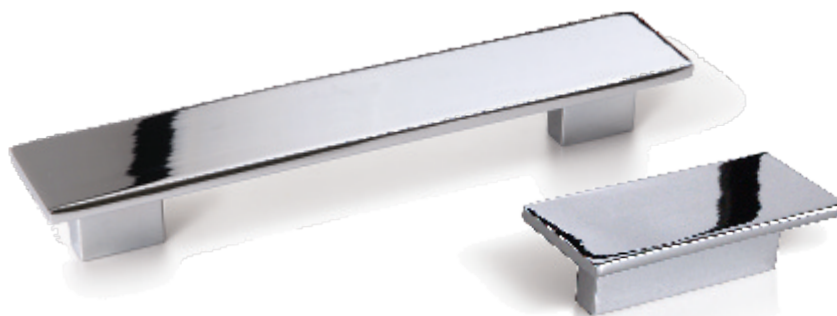

ZnAl

material



color



## Uchwyt UZ-872

Handle UZ-872 / Ручка UZ-872

Index: UZ-872224-..  
(color)

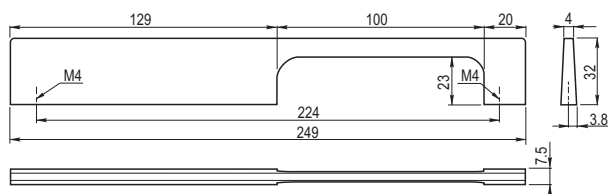
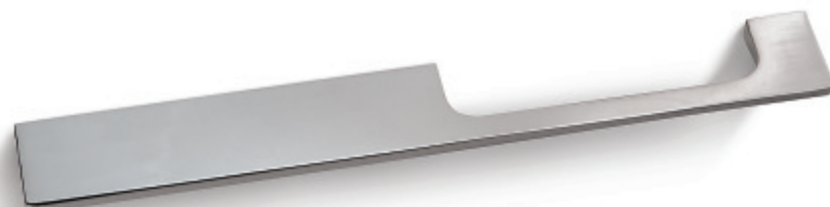

ZnAl

material



color



## Uchwyt UZ-880

Handle UZ-880 / Ручка UZ-880

Index: UZ-880016-..  
(color)

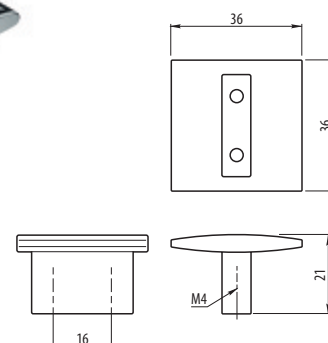

ZnAl

material



color



## Uchwyt UZ-883

Handle UZ-883 / Ручка UZ-883

Index: UZ-883016-...  
(color)

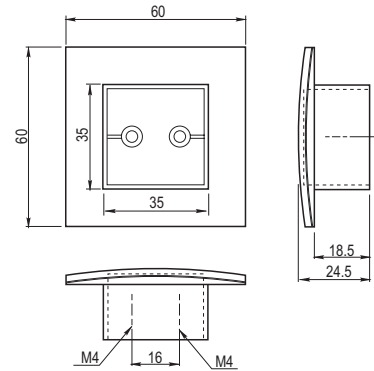
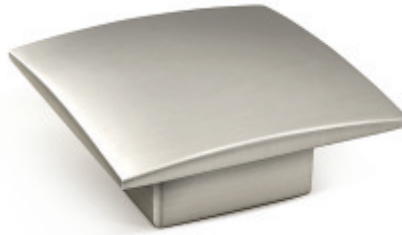

ZnAl

material



color



## Uchwyt UZ-W20

Handle UZ-W20 / Ручка UZ-W20

Index: UZ-W20...-...  
(C) (color)

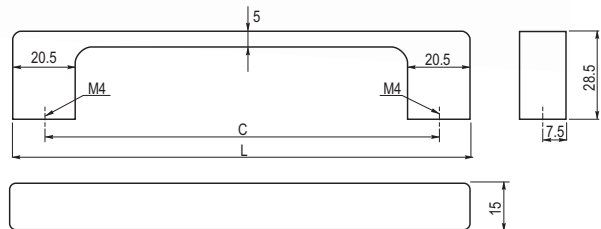

ZnAl

material



color



size

C 96 128  
L 118 150

## Uchwyt UZ-WP146

Handle UZ-WP146 / Ручка UZ-WP146

Index: UZ-WP1146-04



details

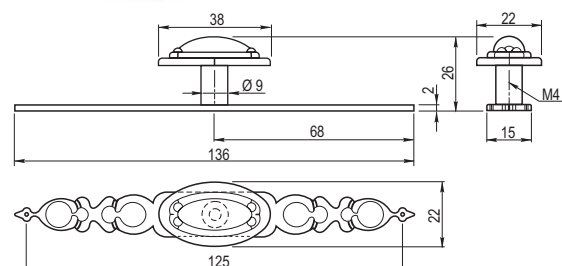

ZnAl

material



color



## Uchwyt UZ-WP1192

Handle UZ-WP1192 / Ручка UZ-WP1192

Index: UZ-WP1192-01

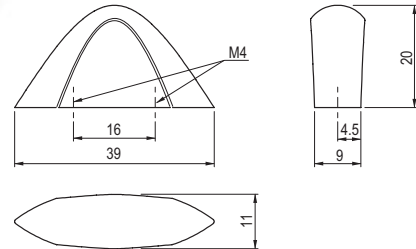

ZnAl

material



color

## Uchwyt UZ-Z08

Handle UZ-Z08 / Ручка UZ-Z08

Index: UZ-Z08128-...  
(color)

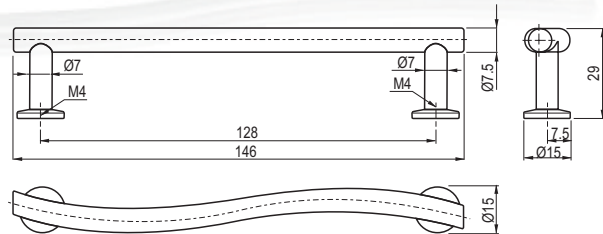

ZnAl

material



color

## Uchwyt UZ-Z10

Handle UZ-Z10 / Ручка UZ-Z10

Index: UZ-Z10...-...  
(C) (color)

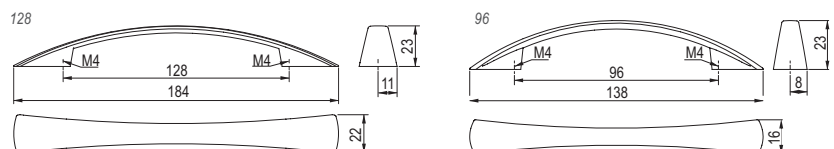

ZnAl

material



color



## Uchwyt UA-18

Handle UA-18 / Ручка UA-18

Index: UA-18-.....\* , UA-A18...-...\*\*  
(C) (L) (C) (color)

### Cechy produktu / Features / Характеристика товара:

- \*index aluminium / алюминий
- \*\*index stal szorstkowana, chrom / brushed steel, chrome  
шлифованная сталь, хром



aluminium / алюминий



C 128 160 192 224 256 320 400 416 480  
L 146 178 210 242 274 338 418 434 498

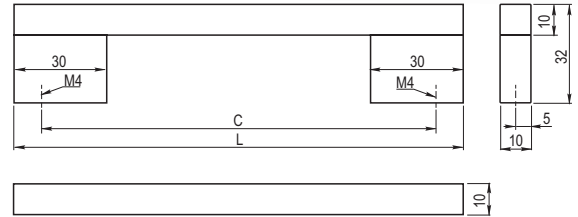

## Uchwyt UA-72H

Handle UA-72H / Ручка UA-72H

Index: UA-72H...-01  
(C)



aluminium / алюминий



C 32 96 128 160 192 256 320  
L 44 108 140 172 204 268 332

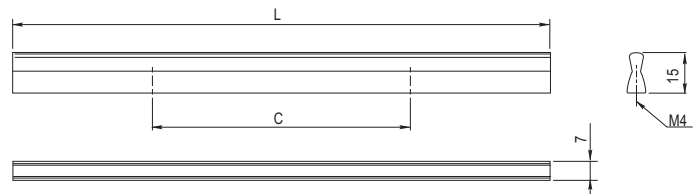

## Uchwyt UA-79F

Handle UA-79F / Ручка UA-79F

Index: UA-79F...-...  
(C) (color)



aluminium / алюминий



C 160 192  
L 184 216

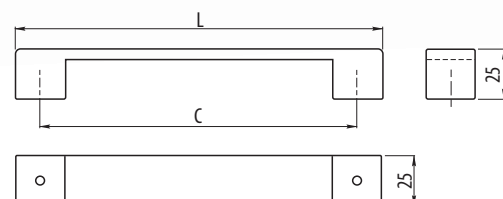

## Uchwyt UA-311

Handle UA-311 / Ручка UA-311

Index: UA-B0-311...<sup>\*</sup>, UA-B311...<sup>\*\*</sup>  
(C) (color)

### Cechy produktu / Features / Характеристика товара:

- <sup>\*</sup>index aluminium / алюминий
- <sup>\*\*</sup>index stal szorstkowana, chrom / brushed steel, chrome  
шлифованная сталь, хром



aluminium / алюминий



C 96 128 160 192 224 256 320 480  
L 116 148 180 212 244 276 340 500

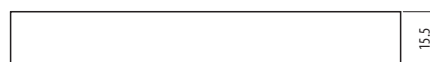
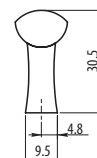
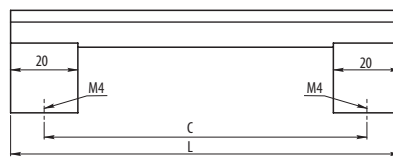

## Uchwyt UA-313

Handle UA-313 / Ручка UA-313

Index: UA-00-313...  
(C)

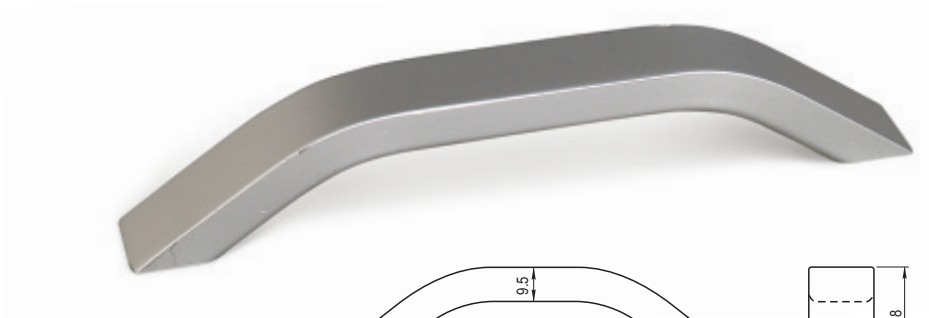

aluminium / алюминий



C 96 128 160 192 224 256 320  
L 118 150 182 214 246 278 342

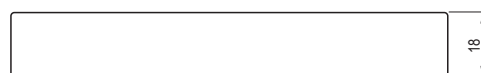
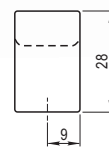
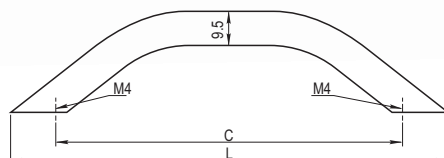

## Uchwyt UA-314

Handle UA-314 / Ручка UA-314

Index: UA-00-314...  
(C)

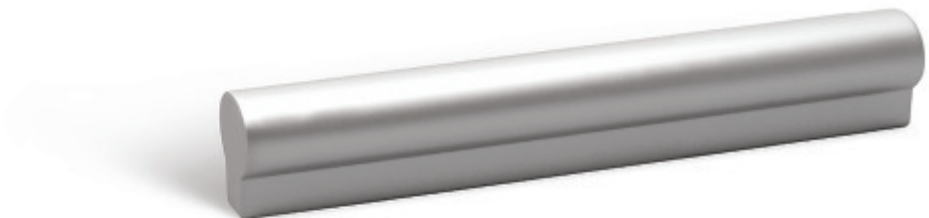

aluminium / алюминий



C 32 64 96 128 160 192 224  
L 50 90 120 150 200 250 300

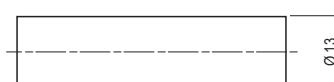
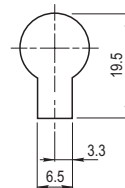
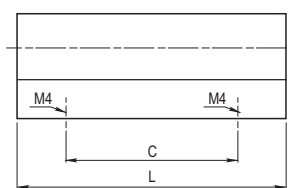

## Uchwyt UA-315

Handle UA-315 / Ручка UA-315

Index: UA-00-315...  
(C)



aluminium / алюминий



C 96 128 160 192 224 256 288 320  
L 135 167 199 231 263 295 327 359

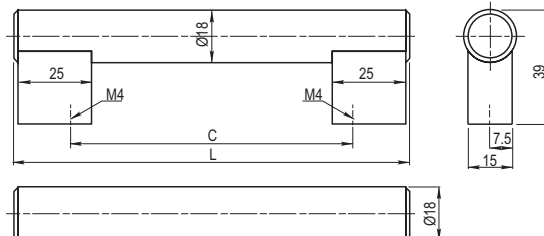

## Uchwyt UA-316

Handle UA-316 / Ручка UA-316

Index: UA-00-316...  
(C)



aluminium / алюминий



C 64 96 128 160 192  
L 101 131 161 211 261

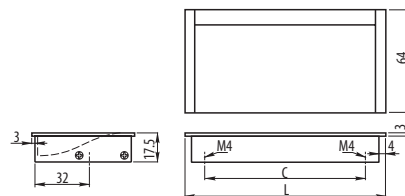

## Uchwyt UA-D316

Handle UA-D316 / Ручка UA-D316

Index: UA-D316...-06  
(C)

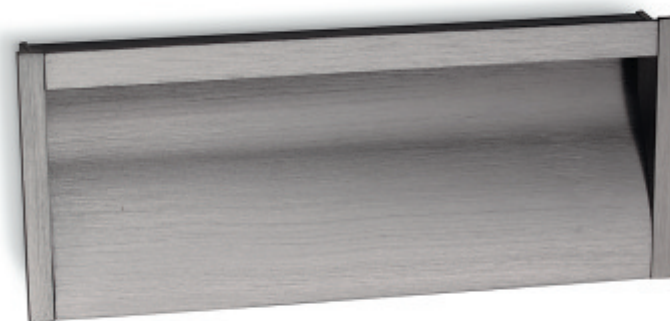

aluminium / алюминий



C 96 128 160 192  
L 120 150 200 250

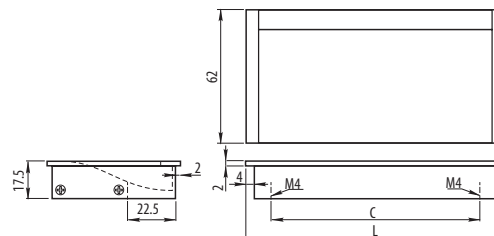

## Uchwyt UA-319

Handle UA-319 / Ручка UA-319

Index: UA-00-319...  
(C)



aluminium / алюминий



color



size

C 96 128 160  
L 158 189 231

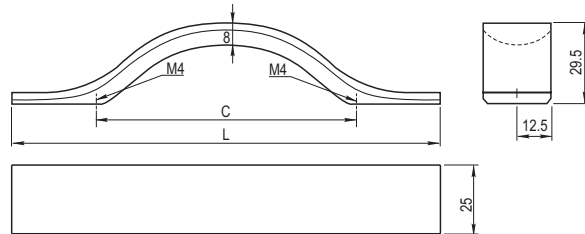

## Uchwyt UA-322

Handle UA-322 / Ручка UA-322

Index: UA-00-322...  
(C)



aluminium / алюминий



color



size

C 96 128 160 192 224 256 320  
L 120 150 200 250 300 350 400

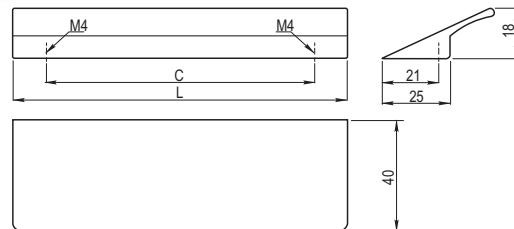

## Uchwyt UA-326/1

Handle UA-326/1 / Ручка UA-326/1

Index: UA-00-326...\*, UA-01-326...\*\*  
(C) (C)

Cechy produktu / Features / Характеристика товара:

- \* index aluminium / алюминий
- \*\* index aluminium + chrom / aluminium + chrome  
алюминий + хром

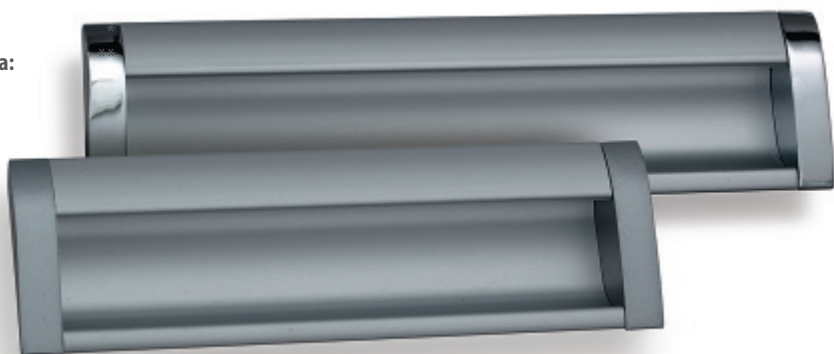

aluminium / алюминий



color



size

C 96 128 160 192  
L 108 140 172 204

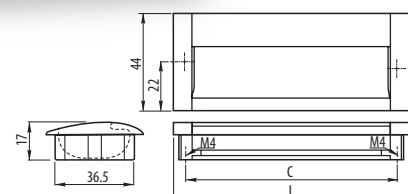

## Uchwyt UA-326/2

Handle UA-326/2 / Ручка UA-326/2

Index: UA--326...-...  
(C)(color)

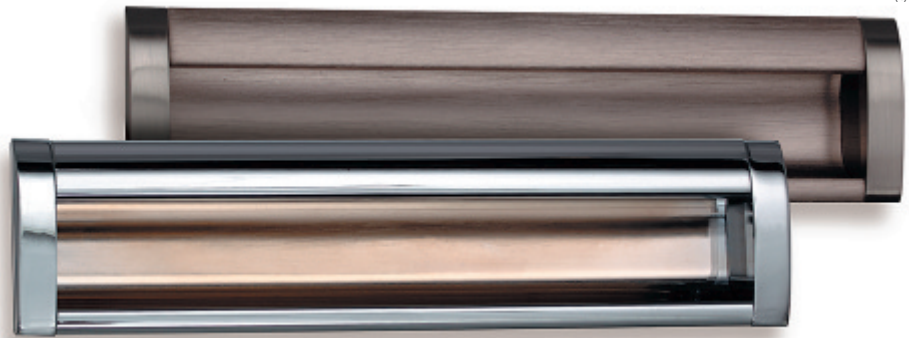

aluminium / алюминий



C	96	128	160	192
L	108	140	172	204

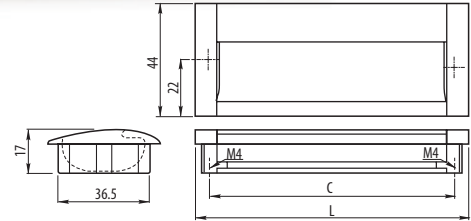

## Uchwyt UA-330

Handle UA-330 / Ручка UA-330

Index: UA-00-330...  
(C)



aluminium / алюминий



C	128	160	320
L	168	200	360

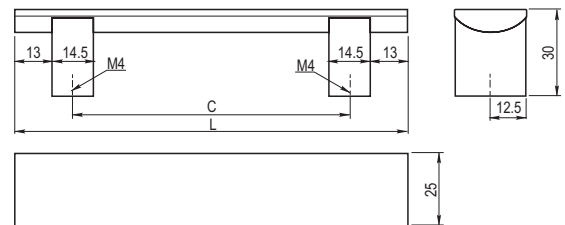

## Uchwyt UA-333

Handle UA-333 / Ручка UA-333

Index: UA-00-333...  
(C)



aluminium / алюминий



C	32	64	96	128	160	192	224
L	50	90	120	150	200	250	300

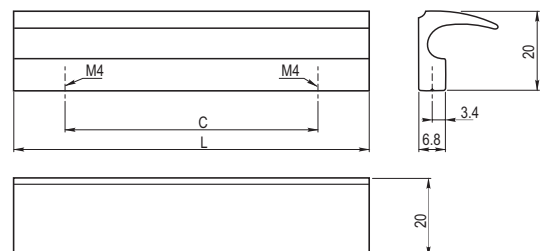

## Uchwyt UA-337

Handle UA-337 / Ручка UA-337

Index: UA-00-337...  
(C)

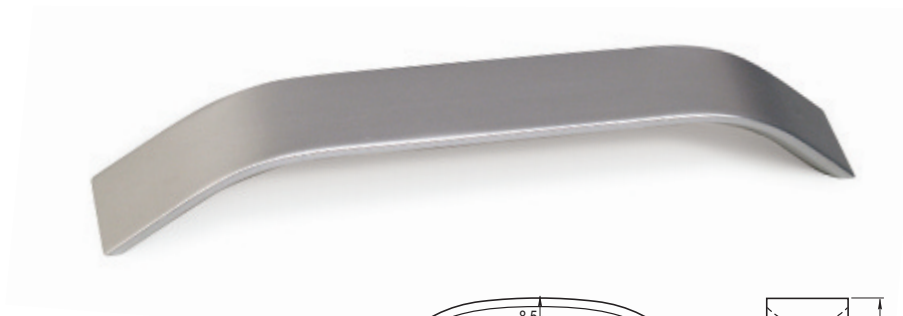

aluminium / алюминий



C 96 128 160 192 224 256 288 320  
L 116 148 180 212 244 276 308 340

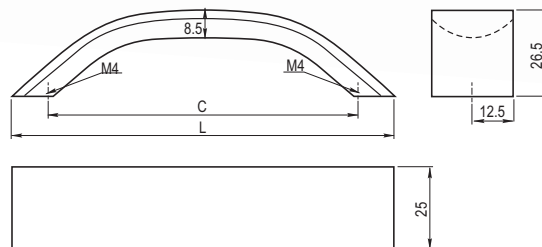

## Uchwyt UA-338

Handle UA-338 / Ручка UA-338

Index: UA-00-338...  
(C)

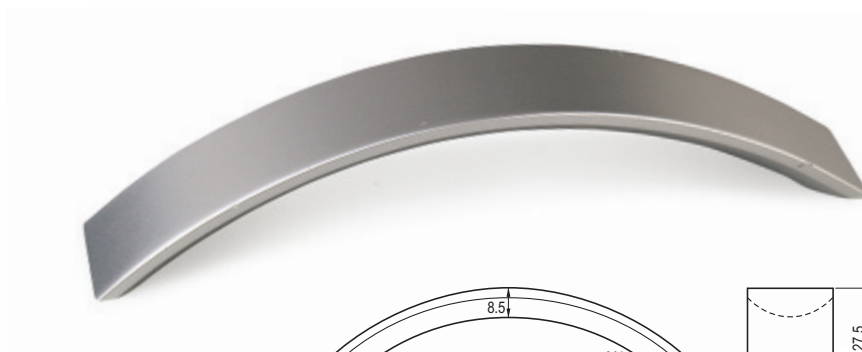

aluminium / алюминий



C 96 128 160  
L 114 151 189

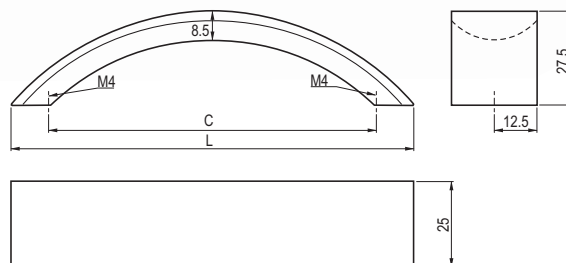

## Uchwyt UA-340

Handle UA-340 / Ручка UA-340

Index: UA-00-340...  
(C)

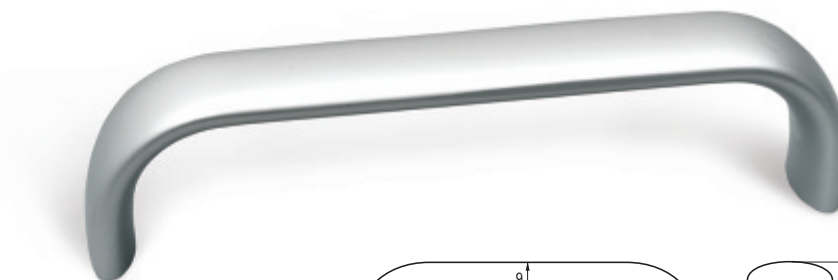

aluminium / алюминий



C 96 128 160 192 224 256 320  
L 105 137 169 201 233 265 329

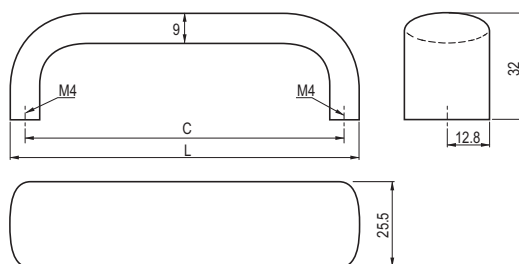

## Uchwyt UA-341

Handle UA-341 / Ручка UA-341

Index: UA-00-341...  
(C)

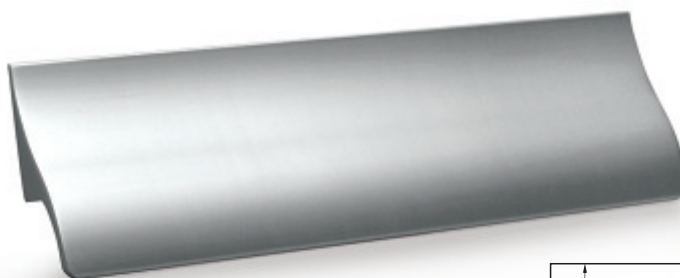

aluminium / алюминий



C 64 96 128 160 192 224 256 320  
L 90 120 150 200 250 300 350 400

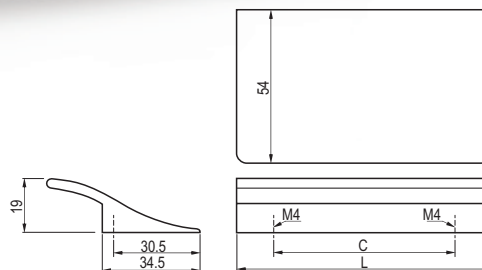

## Uchwyt UA-347

Handle UA-347 / Ручка UA-347

Index: UA-00-347...  
(C)



aluminium / алюминий



C 96 128 160 192 224 256 320  
L 104 136 168 200 232 264 328

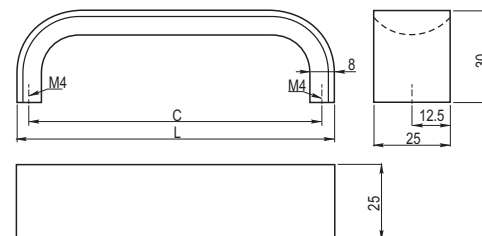

## Uchwyt UA-356

Handle UA-356 / Ручка UA-356

Index: UA-00-356...  
(C)



aluminium / алюминий



L 90 120 150

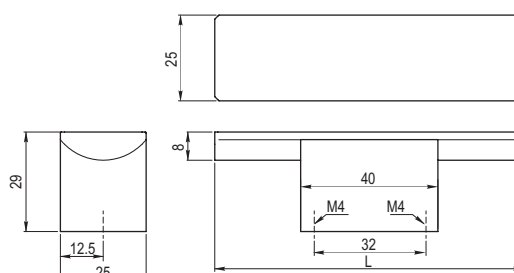

## Uchwyt UA-358

Handle UA-358 / Ручка UA-358

Index: UA-00-358...  
(C)

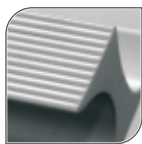

details



aluminium / алюминий



color



C	128	160	192
L	150	200	232

size

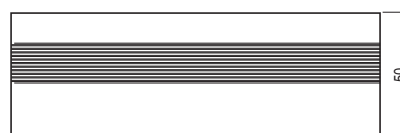
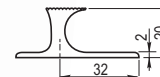
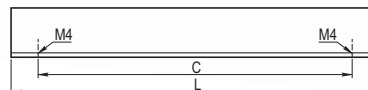

## Uchwyt UA-380

Handle UA-380 / Ручка UA-380

Index: UA-00-380...  
(C)



aluminium / алюминий



color



C	96	128	160	192	224	256	320
L	128	160	192	224	256	288	352

size

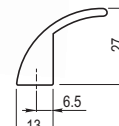
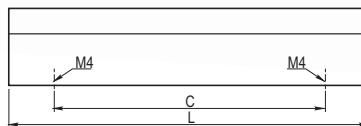

## Uchwyt UA-385

Handle UA-385 / Ручка UA-385

Index: UA-00-385...  
(C)



aluminium / алюминий



color



C	96	128	160	192	224	256	320
L	128	160	192	224	256	288	352

size

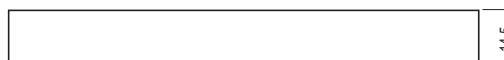
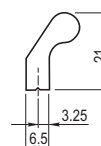
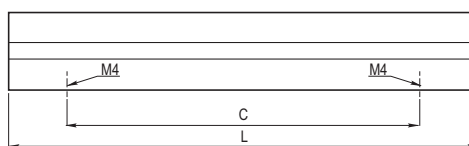

## Uchwyt UA-387

Handle UA-387 / Ручка UA-387

Index: UA-00-387...  
(C)

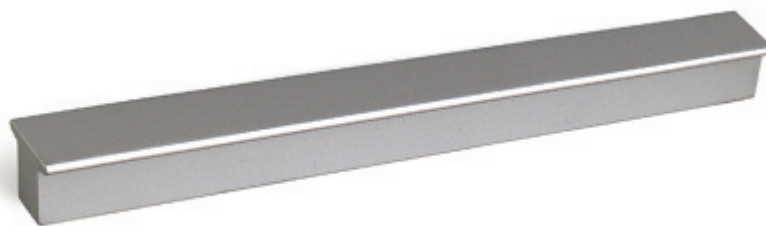

aluminium / алюминий



C 96 128 160 192 224 256 288 320  
L 128 160 192 224 256 288 320 352

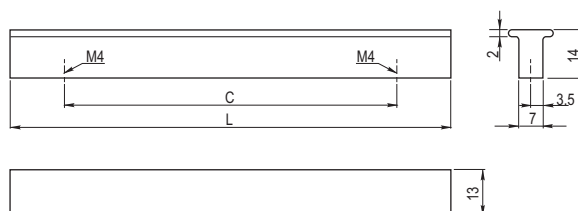

## Uchwyt UA-709

Handle UA-709 / Ручка UA-709

Index: UA-709...-...  
(C) (color)



aluminium / алюминий



C 16 160 256  
L 33 177 273

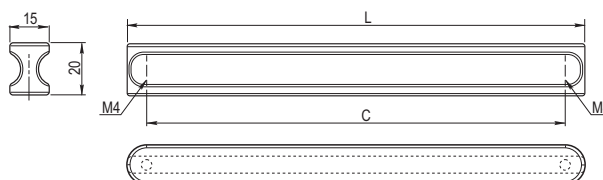

## Uchwyt UA-A3

Handle UA-A3 / Ручка UA-A3

Index: UA-AA-03...\*, UA-A3...-06\*\*  
(C) (C)

Cechy produktu / Features / Характеристика товара:

- \*index aluminium / алюминий
- \*\* index stal szcztokowana / brushed steel  
шлифованная сталь

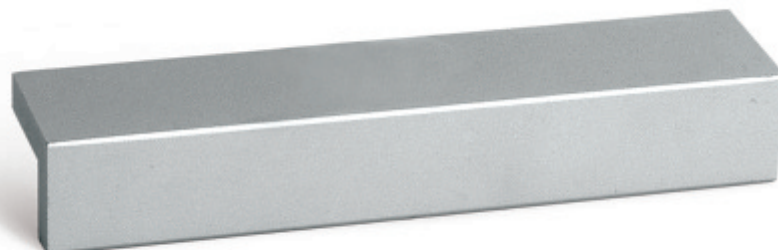

aluminium / алюминий



C 64 96 128 160 192 224 256 320 480  
L 96 128 160 192 224 256 288 352 512

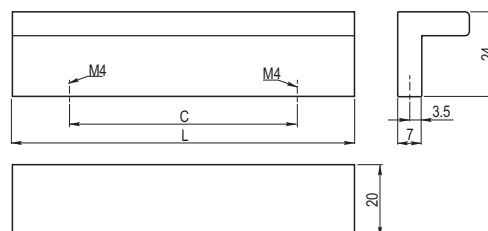

## Uchwyt UA-A4

Handle UA-A4 / Ручка UA-A4

Index: UA-AA-04-...<sup>\*</sup>, UA-A4-...-06<sup>\*\*</sup>  
(C) (C)

### Cechy produktu / Features / Характеристика товара:

- \*index aluminium / алюминий
- \*\*index stal szcztokowana, chrom  
brushed steel, chrome  
шлифованная сталь, хром



aluminium / алюминий



C 96 128 160 192 224 256 288 320  
L 116 148 180 212 244 276 308 340

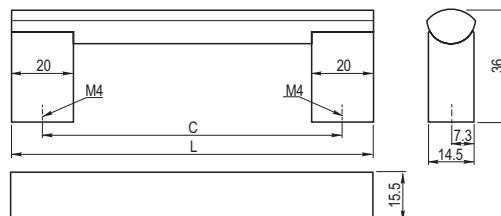

## Uchwyt UA-A6

Handle UA-A6 / Ручка UA-A6

Index: UA-AA-06-...<sup>\*</sup>, UA-A6-...-06<sup>\*\*</sup>  
(C) (C)

### Cechy produktu / Features / Характеристика товара:

- \*index aluminium / алюминий
- \*\*index stal szcztokowana, chrom  
brushed steel, chrome  
шлифованная сталь, хром



aluminium / алюминий



C 64 84 128 160 192 224 256 288 320 416 480  
L 96 128 160 192 224 256 288 320 352 448 512

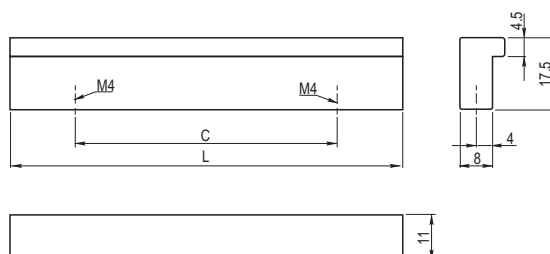
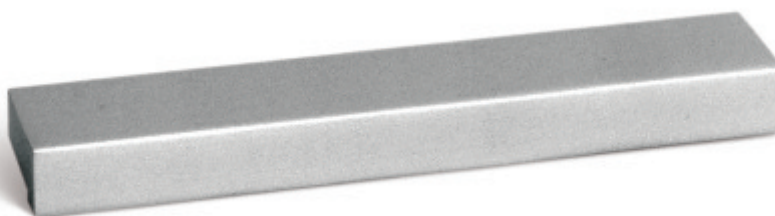

## Uchwyt UA-A7

Handle UA-A7 / Ручка UA-A7

Index: UA-AA-07-...<sup>\*</sup>, UA-A7-...-06<sup>\*\*</sup>  
(C) (C)

### Cechy produktu / Features / Характеристика товара:

- \*index aluminium / алюминий
- \*\*index stal szcztokowana / brushed steel  
шлифованная сталь



aluminium / алюминий



C 32 64 96 128 160 192 224 256 288 320  
L 64 96 128 160 192 224 256 288 320 352

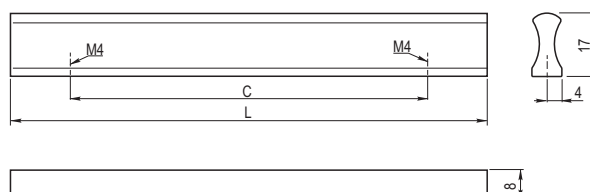

## Uchwyt UA-A19

Handle UA-A19 / Ручка UA-A19

Index: UA-A19...06  
(C)

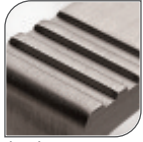

details

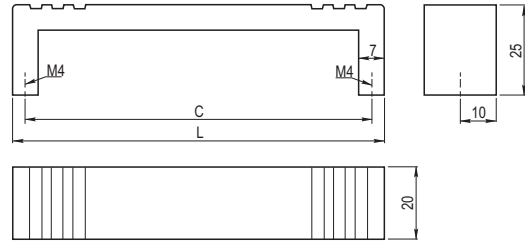
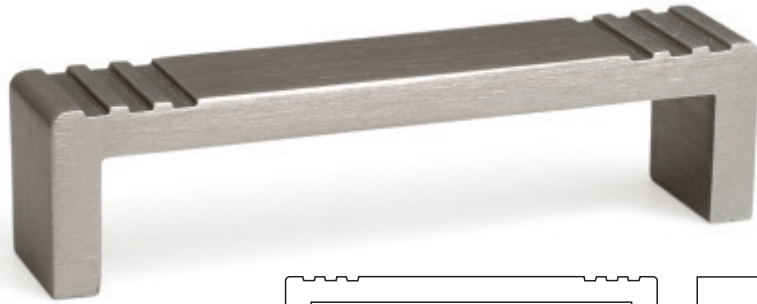

aluminium / алюминий



color



C 96 128 160  
L 103 135 167

## Uchwyt UA-B337

Handle UA-B337 / Ручка UA-B337

Index: UA-B0-337...\*, UA-B337...06\*\*  
(C) (C)

### Cechy produktu / Features / Характеристика товара:

- \*index aluminium / алюминий
- \*\*index stal szczotkowana, chrom  
шлифованная сталь, хром

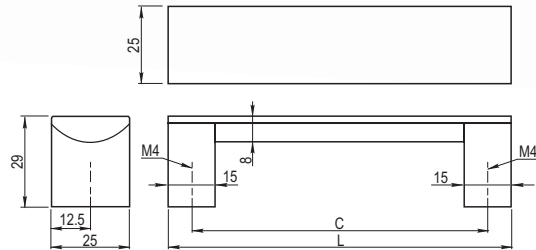

aluminium / алюминий



color



C 96 128 160 192 224 256 320 416 480  
L 111 134 175 207 239 271 335 431 495

## Uchwyt relingowy RS

Handle RS / Релинговая ручка RS

Index: RS.....-..  
(L)(C) (color)

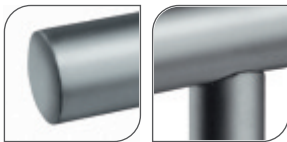

details

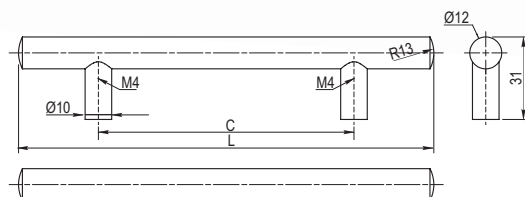

stal / steel / сталь



color



C 96 128 160 192 224 256 288 320 352 384 416 480 512 544 576 508 640 672 704 736 768 800  
L 156 188 220 272 304 336 368 400 432 464 496 560 592 624 656 688 720 752 784 856 888 920

## Uchwyt US-SKN

Handle US-SKN / Ручка US-SKN

Index: US-SKN...-06  
(C)



stal / steel / сталь



C 128 160 192 224 256 416 448  
L 138 170 202 234 266 426 458

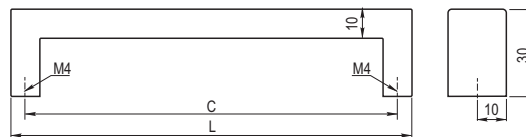

## Uchwyt US-SKO

Handle US-SKO / Ручка US-SKO

Index: US-SKO...-06  
(C)



stal / steel / сталь



C 128 160 192 224 256 288 320 352 384 416 448 480 576 672 800  
L 143 175 207 239 271 303 335 367 399 431 463 495 591 687 815

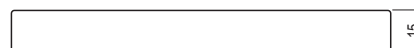
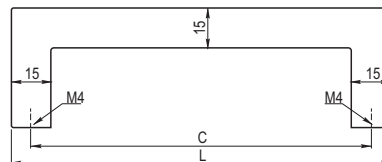

## Uchwyt UZ-12

Handle UZ-12 / Ручка UZ-12

Index: UZ-12-096-04



stal / steel / сталь

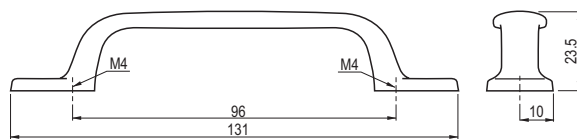

## Kolekcja uchwytów LYON

Handles collection LYON / Коллекция ручек LYON

Index: UZ-LONG01-04, UZ-LON064-04, UZ-LON096-04



details

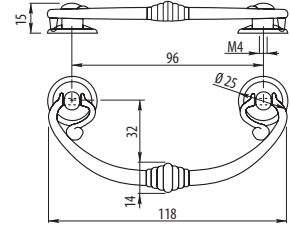
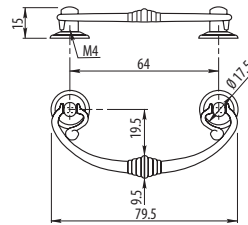
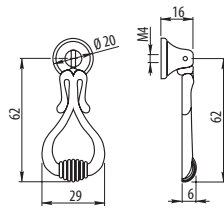

## Kolekcja uchwytów NICE

Handles collection NICE / Коллекция ручек NICE

Index: UZ-NICG01-04, UZ-NIC064-04, UZ-NIC096-04



details

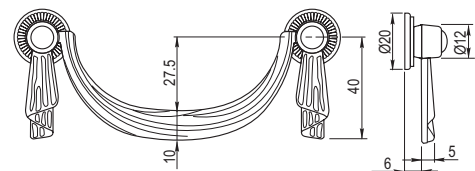
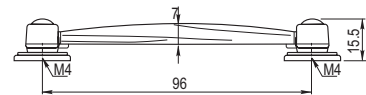
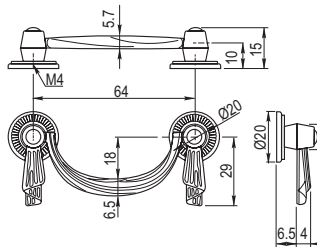
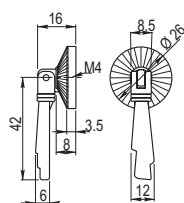

## Kolekcja uchwytów LILLE

Handles collection LILLE / Коллекция ручек LILLE

Index: UZ-LILG01-04, UZ-LIL064-04, UZ-LIL096-04



details



ZnAl

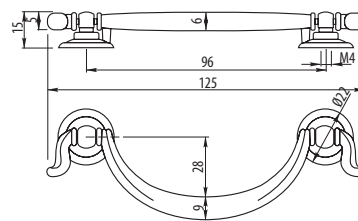
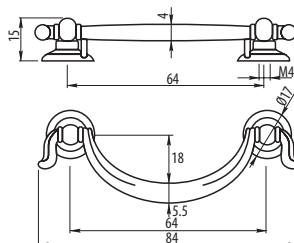
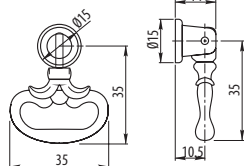

UZ-LILG01-04

UZ-LIL064-04

UZ-LIL096-04

## Kolekcja uchwytów ETIENNE

Handles collection ETIENNE / Коллекция ручек ETIENNE

Index: UZ-ETI064-04, UZ-ETI096-04



details



ZnAl

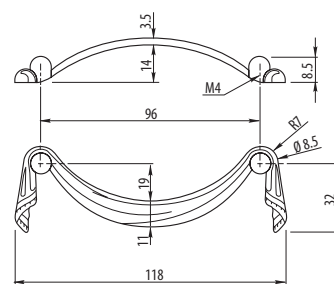
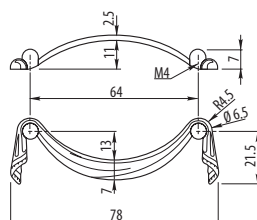

UZ-ETI064-04

UZ-ETI096-04

# Kolekcja uchwytów RENNES

Handles collection RENNES / Коллекция ручек RENNES

Index: UZ-RENG01-04, UZ-RENG02-04, UZ-RENG064-04, UZ-RENG096-04



details



UZ-RENG01-04

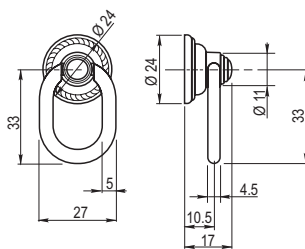

UZ-RENG02-04

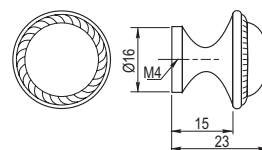

UZ-RENG064-04

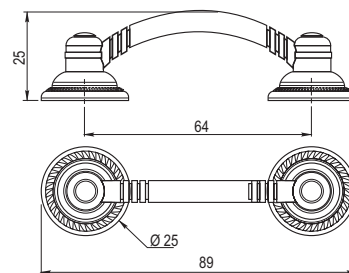

UZ-RENG096-04

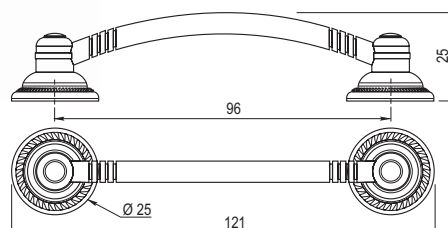

ZnAl

material



color



34

# Kolekcja uchwytów mozaikowych

Collection of mosaic handles / Коллекция мозаиковых ручек



details

## Uchwyt A1

Handle A1 / Ручка A1

Index: UZ-888...-A1  
(C)



ZnAl



color



C 96 128  
L 121 158



size

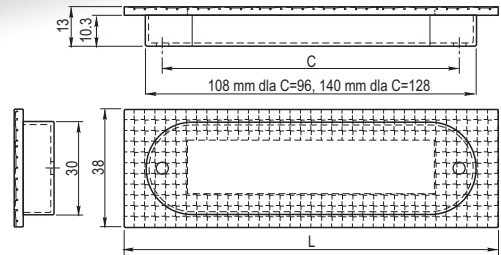
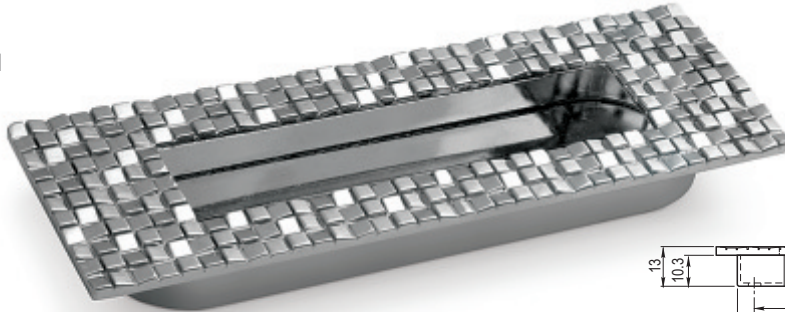

## Uchwyt B1

Handle B1 / Ручка B1

Index: UZ-888000-B1



ZnAl



color



C 96 128  
L 121 158



size

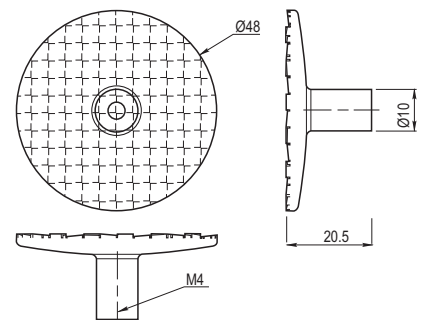

## Uchwyt C1

Handle C1 / Ручка C1

Index: UZ-888032-C1



ZnAl



color



C 96 128  
L 121 158



size

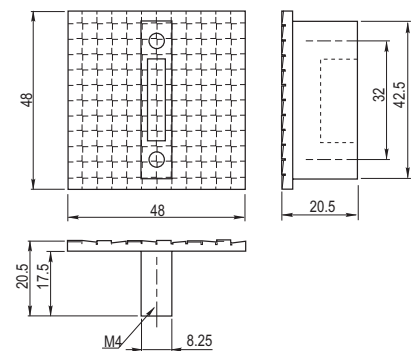

## Uchwyt D1

Handle D1 / Ручка D1

Index: UZ-888032-D1



ZnAl



color

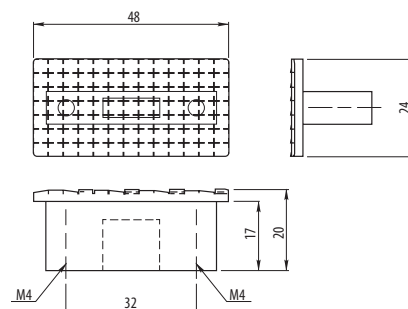

## Uchwyt E1

Handle E1 / Ручка E1

Index: UZ-888...-E1  
(C)



ZnAl



color



C 128 160  
L 146 178

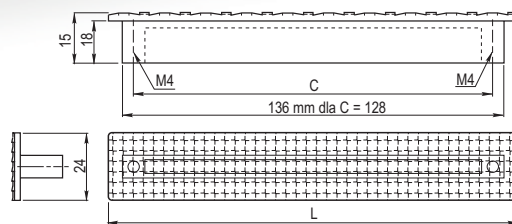
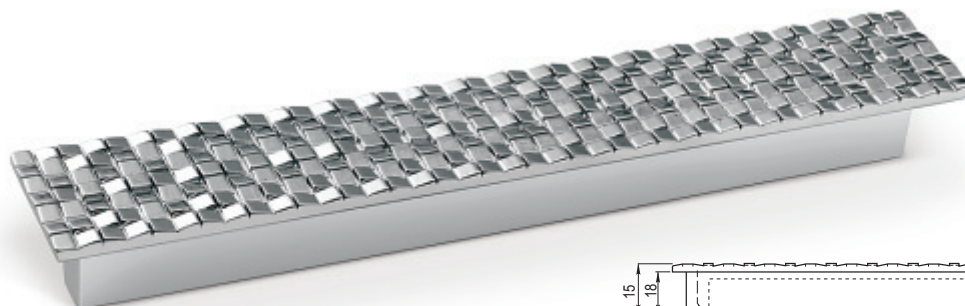

# Kolekcja uchwytów porcelanowych

Porcelain handles / Фарфоровые ручки

## Gałka J4

Knob J4 / Ручка J4



ZnAl + porcelana / porcelain / фарфор



04

Index: GP-0728-J4-

Dostępne motywy: / Available patterns: / Доступные декоративные мотивы:



(motyw)  
(pattern)  
(мотив)

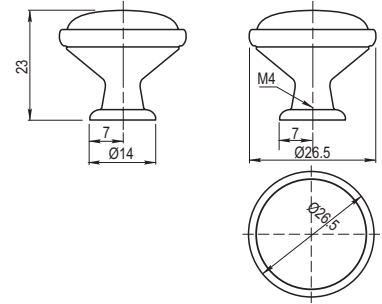

## Gałka I4

Knob I4 / Ручка I4



porcelana / porcelain / фарфор

Index: GP-0728-I4-

Dostępne motywy: / Available patterns: / Доступные декоративные мотивы:



(motyw)  
(pattern)  
(мотив)

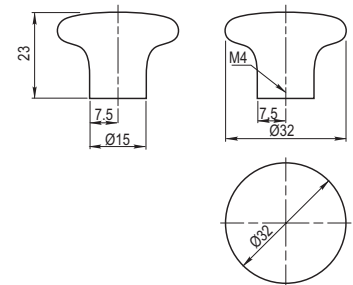

## Gałka 727P

Knob 727P / Ручка 727P



ZnAl + porcelana / porcelain / фарфор



04

Index: GP-WP0727-P-

Dostępne motywy: / Available patterns: / Доступные декоративные мотивы:



(motyw)  
(pattern)  
(мотив)

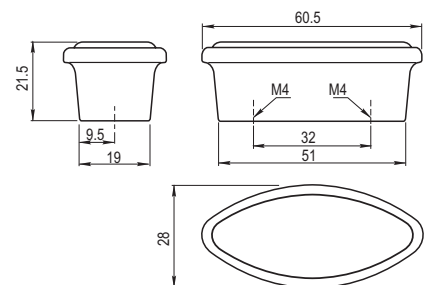

## Uchwyt 728B

Handle 727B / Ручка 727B



ZnAl + porcelana / porcelain / фарфор



color

Index: UP-SP0728-B.

(motyw)  
(pattern)  
(мотив)

Dostępne motywy: / Available patterns: / Доступные декоративные мотивы:

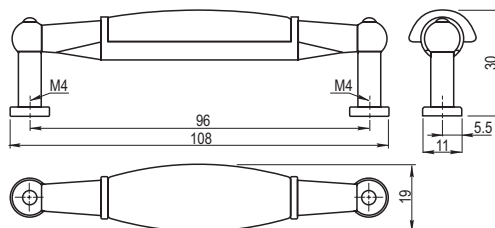

## Uchwyt 728P

Handle 728P / Ручка 728P



ZnAl + porcelana / porcelain / фарфор



color

Index: UP-WP0728-P.

(motyw)  
(pattern)  
(мотив)

Dostępne motywy: / Available patterns: / Доступные декоративные мотивы:

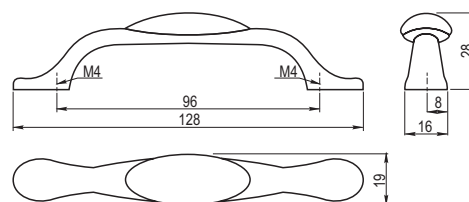

## Uchwyt 727P

Handle 727P / Ручка 727P



ZnAl + porcelana / porcelain / фарфор



color

Index: UP-WP0727-P.

(motyw)  
(pattern)  
(мотив)

Dostępne motywy: / Available patterns: / Доступные декоративные мотивы:

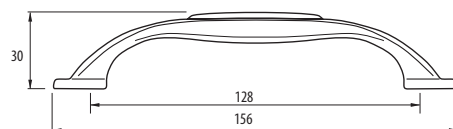

# Kolekcja „Morska fauna”

Marine fauna / Коллекция „Морская фауна”



UM-WP00-B-00

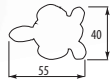

UM-WP00-C-00

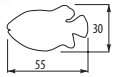

UM-WP00-D-00



UM-WP00-I-00

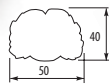

UM-WP00-E-00

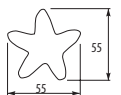

UM-WP00-A-00

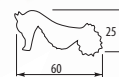

UM-WP00-F-00



UM-WP00-J-00

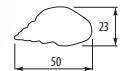

UM-WP00-G-00



UM-WP00-K-00

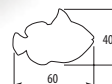

UM-WP00-H-00



# Kolekcja „Leśne skrzaty”

Dwarf knobs / Ручки „Гномики”



UM-KRASN-001

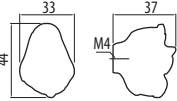

UM-KRASN-002

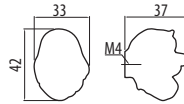

UM-KRASN-003

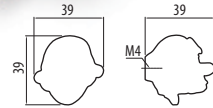

UM-KRASN-004

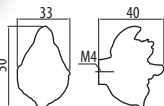

UM-KRASN-006

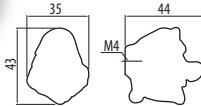

UM-KRASN-005

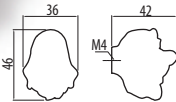

UM-KRASN-007

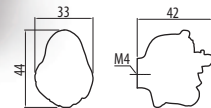

# Gumowe uchwyty dziecięce

Rubber-made child handles / Резиновые детские ручки



UM-KID-E-001

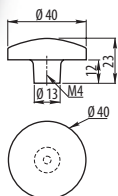

UM-KID-C-001

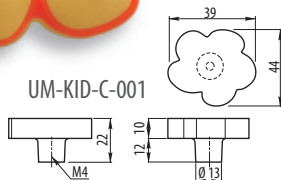

UM-KID-D-001

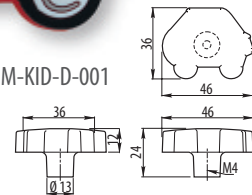

UM-KID-F-001

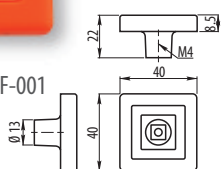

UM-KID-A-001

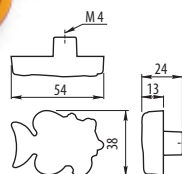

UM-KID-B-001

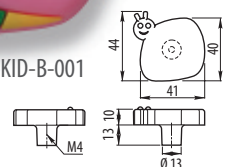

## Kolekcja uchwytów koszykowych

Plated handles / Плетеные ручки

### Uchwyt P500

Knob P500 / Ручка P500

Index: US-P500..-..  
(L) (color)



material

stal / steel / сталь



color



size

L 35 40

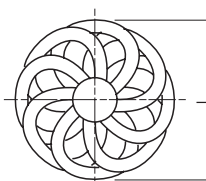
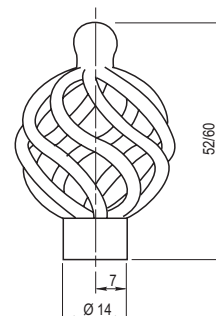
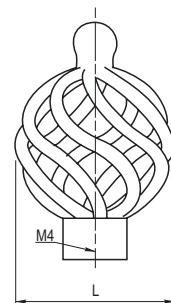

### Uchwyt P700

Knob P700 / Ручка P700

Index: US-P700..-..  
(L) (color)



material

stal / steel / сталь



color



size

L 35 43

H 35 39

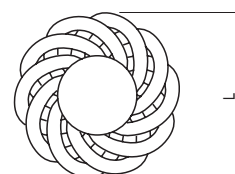
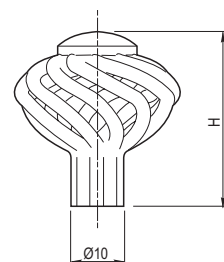
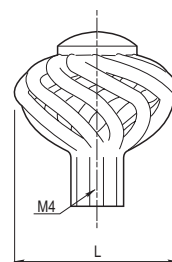

## Uchwyt P100

Knob P100 / Ручка P100

Index: US-P100...-...  
(L) (color)

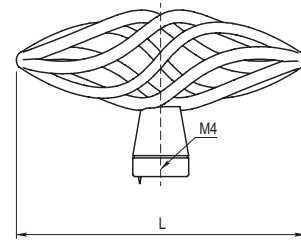
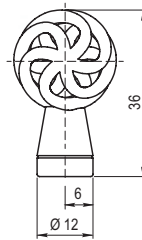
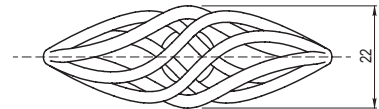

material

stal / steel / сталь



color



size

L 62 74

## Uchwyt P60

Knob P60 / Ручка P60

Index: US-P60...-...  
(C) (color)

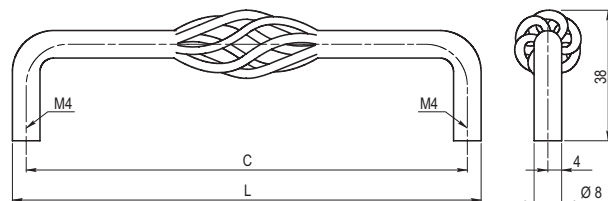

material

stal / steel / сталь



color



size

C 96 128

L 104 136

### Gałka GZ-943

Knob GZ-943 / Ручка GZ-943

Index: GZ-WP0943-..  
(color)

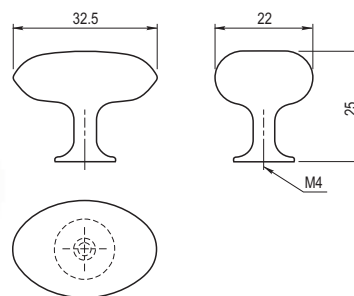

ZnAl

material



color



### Gałka GZ-955

Knob GZ-955 / Ручка GZ-955

Index: GZ-WP0955-..  
(color)

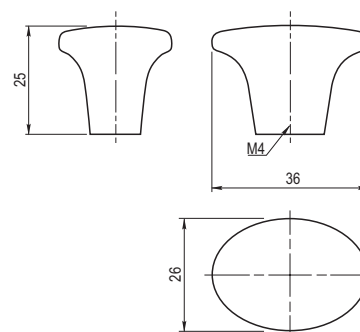

ZnAl

material



color



### Gałka GZ-1136

Knob GZ-1136 / Ручка GZ-1136

Index: GZ-WP1136-04



details

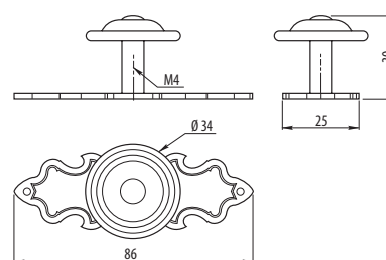

ZnAl

material



color



## Gałka GZ-1148

Knob GZ-1148 / Ручка GZ-1148

Index: GZ-WP1148-04



details

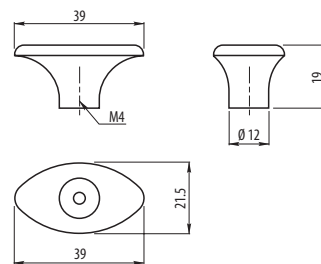

material

ZnAl



color



## Gałka GZ-1152

Knob GZ-1152 / Ручка GZ-1152

Index: GZ-WP1152-04

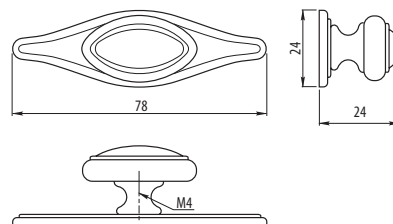

material

ZnAl



color



## Gałka GZ-1153

Knob GZ-1153 / Ручка GZ-1153

Index: GZ-WP1153-..  
(color)



details

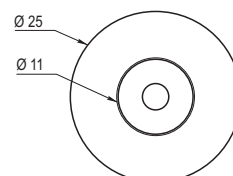
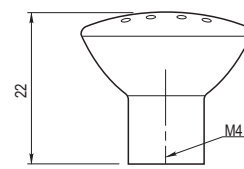

material

ZnAl



color



### Gałka GZ-1154

Knob GZ-943 / Ручка GZ-943

Index: GZ-WP1154-..  
(color)

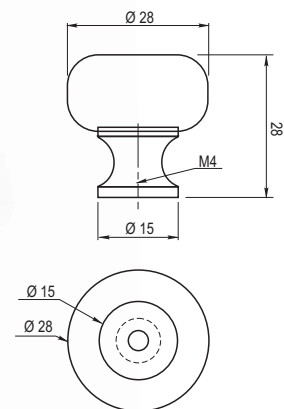

ZnAl

material



color



### Gałka GZ-1155

Knob GZ-1155 / Ручка GZ-1155

Index: GZ-WP1155-..  
(color)

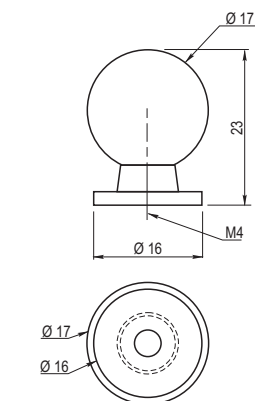

ZnAl

material



color



### Gałka GZ-1241

Knob GZ-1241 / Ручка GZ-1241

Index: GZ-WP1241-04



details

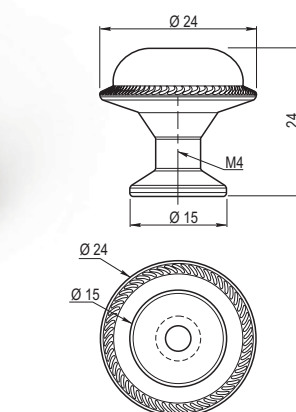

ZnAl

material



color



## Gałka GZ-ZH-11

Knob GZ-ZH-11 / Ручка GZ-ZH-11

Index: GZ-ZH-011-..  
(color)



details

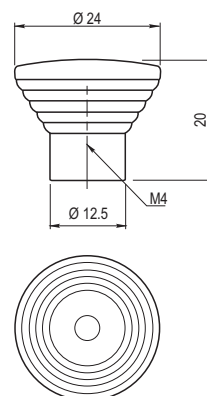

ZnAl

material



color



## Kołatka KT-1147

Knob KT-1147 / Ручка KT-1147

Index: KT-WP1147-..  
(color)



details

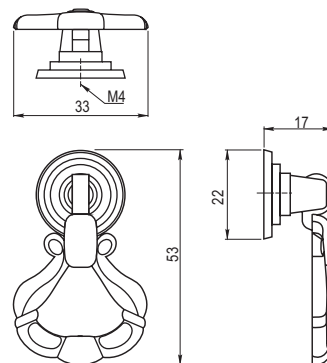

ZnAl

material



color



## Kołatka KT-1244

Knob KT-1244 / Ручка KT-1244

Index: KT-WP1244-..  
(color)



details

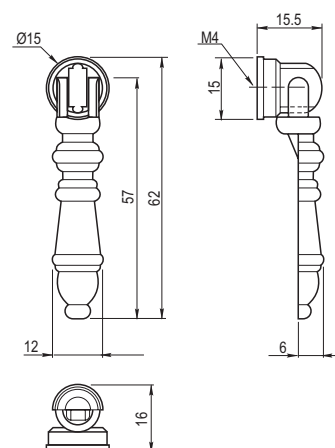

ZnAl

material



color



### Wieszak 00-K24

Hook 00-K24 / Вешалка 00-K24

Index: WZ-00-K24-..  
(color)



details

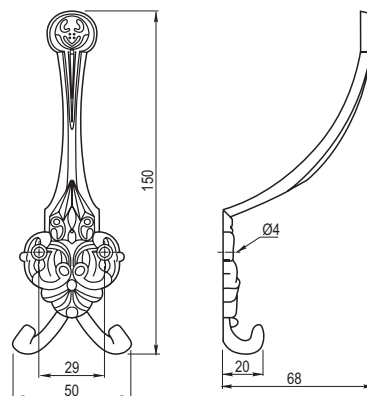

ZnAl

material



color

### Wieszak E18

Hook E18 / Вешалка E18

Index: WZ-E-018-..  
(color)

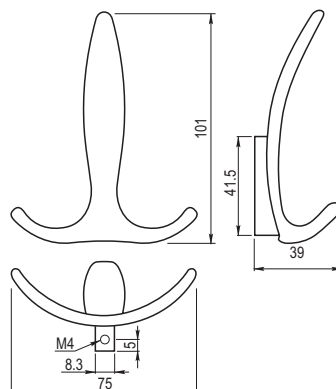

ZnAl

material



color



### Wieszak D70

Hook D70 / Вешалка D70

Index: WZ-D-070-..  
(color)

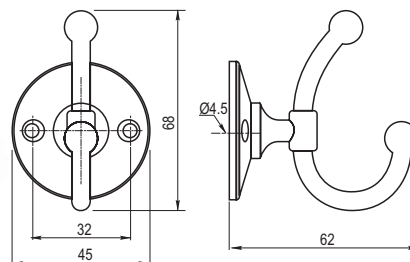

ZnAl

material



color



## Wieszak D110

Hook D110 / Вешалка D110

Index: WZ-D-110-..  
(color)

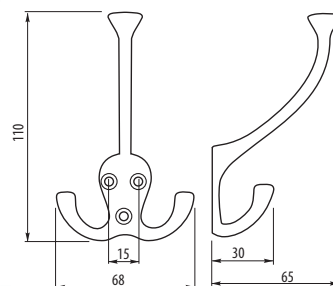

material

ZnAl



color



## Wieszak D117

Hook D117 / Вешалка D117

Index: WZ-D-117-..  
(color)

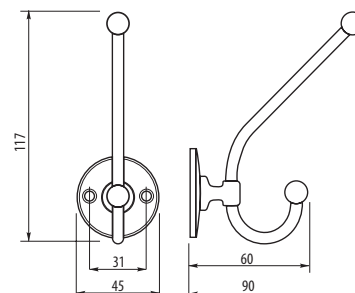

material

ZnAl



color



## Wieszak D138

Hook D138 / Вешалка D138

Index: WZ-D-138-..  
(color)

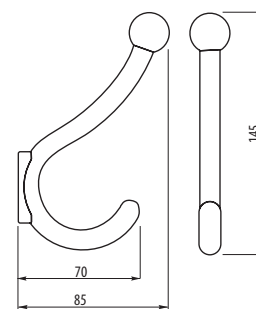

material

ZnAl



color



### Wieszak D892

Hook D892 / Вешалка D892

Index: WZ-D-892-..  
(color)

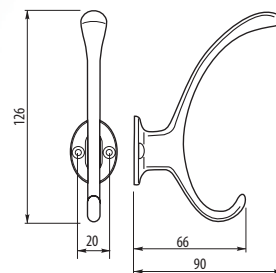

ZnAl

material



color



### Wieszak D956

Hook D956 / Вешалка D956

Index: WZ-D-956-..  
(color)

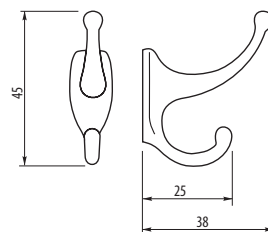

ZnAl

material



color



### Wieszak C0-K24

Hook C0-K24 / Вешалка C0-K24

Index: WZ-C0-K24-..  
(color)

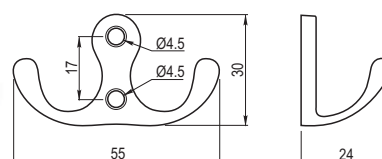

ZnAl

material



color



## Wieszak K23

Hook K23/ Вешалка K23

Index: WZ-A0-K23-.\*, WZ-B0-K23-.\*\*  
(color) (color)



details

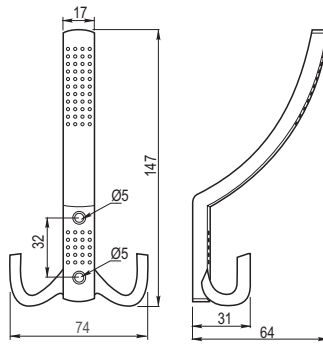

\*



\*\*

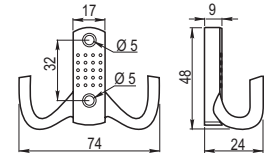

ZnAl

material



color



## Wieszak K24

Hook K24 / Вешалка K24

Index: WZ-A0-K24-.\*, WZ-B0-K24-.\*\*  
(color) (color)

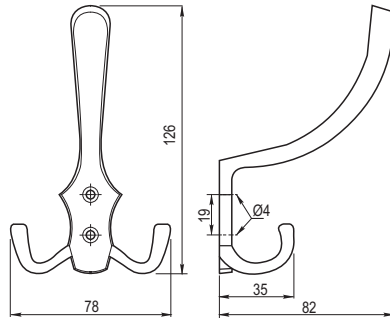

\*



\*\*

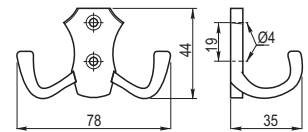

ZnAl

material



color



## Nóżka 1

Leg 1 / Ножка 1

Index: NM-BD-001-..

(color)



material

aluminium + stal / aluminium + steel  
алюминий + сталь



color

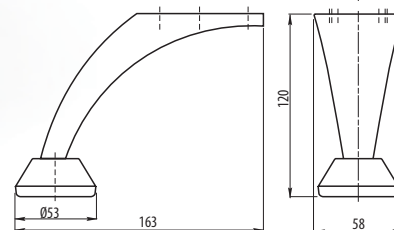
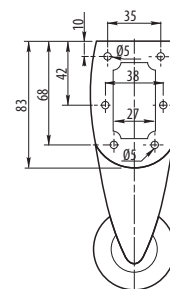

## Nóżka 3

Leg 3 / Ножка 3

Index: NM-BD-003-..

(color)



material

stal / steel / сталь



color

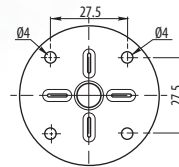
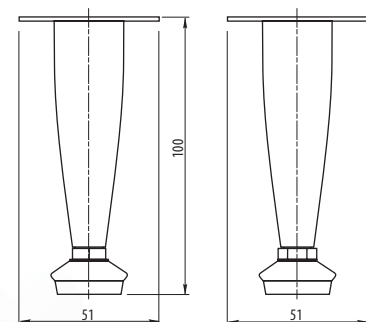

## Nóżki 100 i 150

Legs 100 & 150 / Ножки 100 и 150

Index: NM-BD-100-.., NM-BD-150-..

(color)

(color)

Cechy produktu / Features / Характеристика товара:

- nóżka z regulacją / adjustable leg  
ножка с регулировкой



material

stal / steel / сталь



color

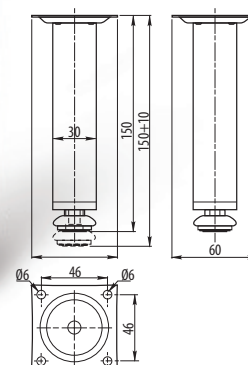
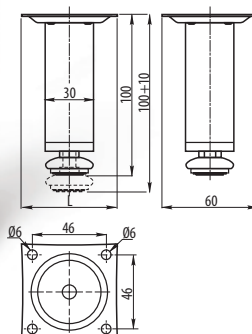

## Nóżka 712

Leg 712 / Ножка 712

Index: NM-BD-712-..., NM-BD-712-M1  
(color)



ZnAl + aluminium / ZnAl + алюминий  
stal / steel / сталь

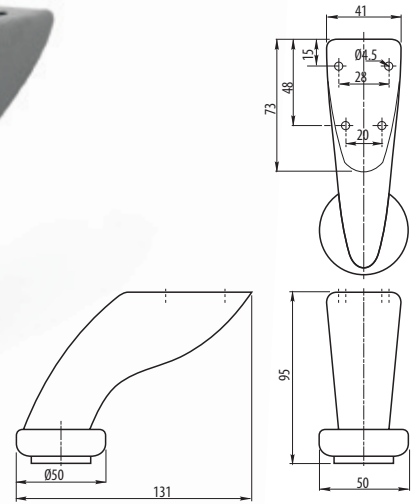

## Nóżka 726

Leg 726 / Ножка 726

Index: NM-BD-726-...  
(color)



ZnAl

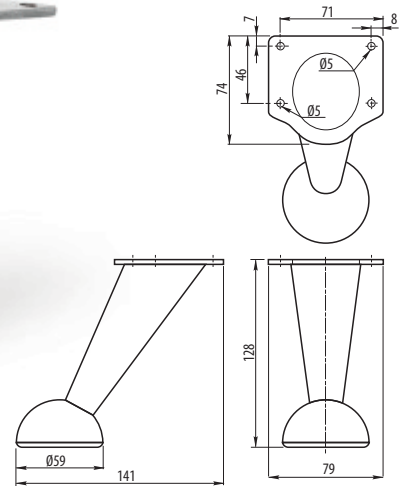

## Nóżka 727

Leg 727 / Ножка 727

Index: NM-BD727-...  
(H)



aluminium / алюминий



H 70 100 120

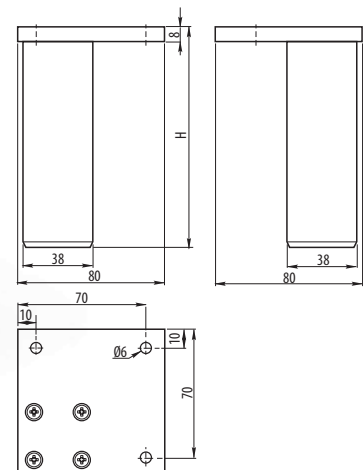

## Nóżka 734

Leg 734 / Ножка 734

Index: NM-BD-734-..  
(color)



material

stal / steel / сталь



color

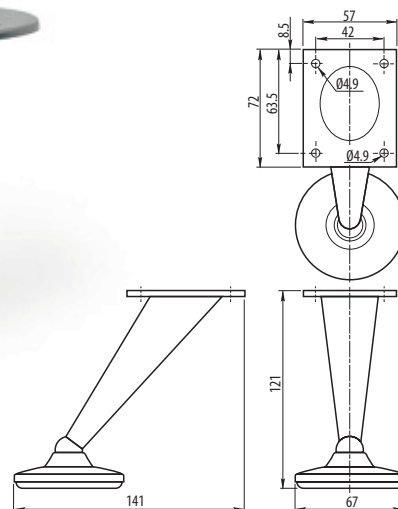

## Nóżka 739

Leg 739 / Ножка 739

Index: NM-BD-739-05



material

stal / steel / сталь



color

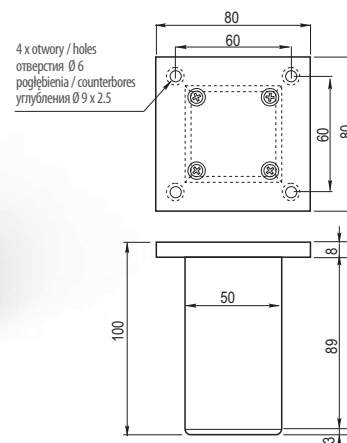

## Nóżka 741

Leg 741 / Ножка 741

Index: NM-BD-741-05



material

aluminium / алюминий



color

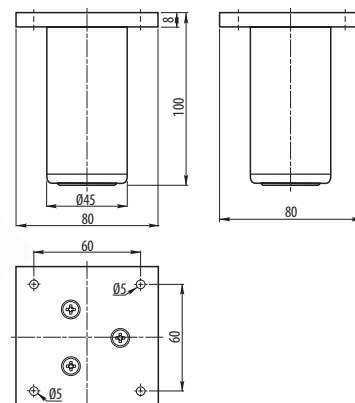

## Nóżka 762

Leg 762 / Ножка 762

Index: NM-BD-762-..  
(color)

Cechy produktu / Features / Характеристика товара:

- nóżka z regulacją / adjustable leg / Ножка с регулировкой



material

stal / steel / сталь



color

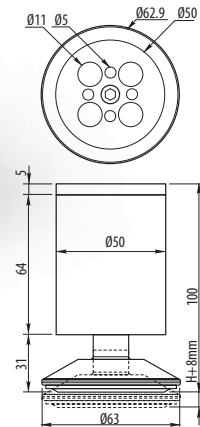

## Nóżka 780

Leg 780 / Ножка 780

Index: NM-BD-780-..  
(color)



material

aluminium + stal / aluminium + steel  
алюминий + сталь



color

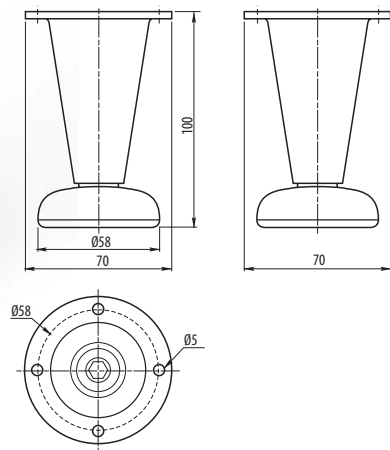

## Nóżka 783

Leg 783 / Ножка 783

Index: NM-BD-783-..  
(color)



material

ZnAl



color

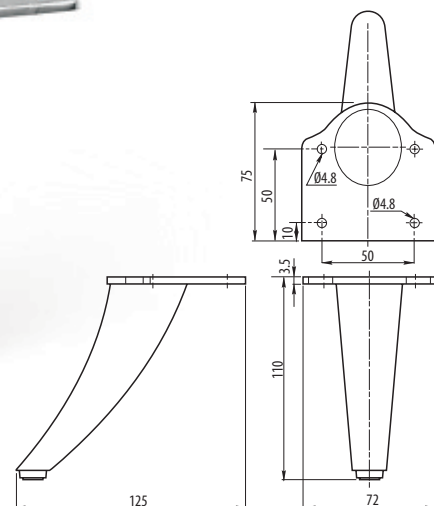

## Nózka 867 i 869

Leg 867 & 869 / Ножка 867 и 869

Index: NM-BD867-100, NM-BD869-150



aluminium / алюминий



color



H 100 150

size

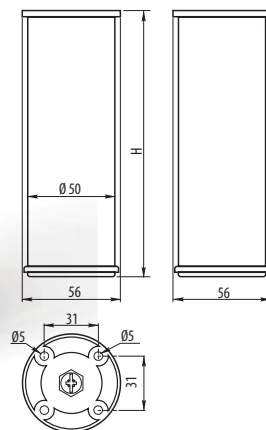

## Nózka 868

Leg 868 / Ножка 868

Index: NM-BD868-...  
(H)



aluminium / алюминий



color



H 100 110 120 150

size

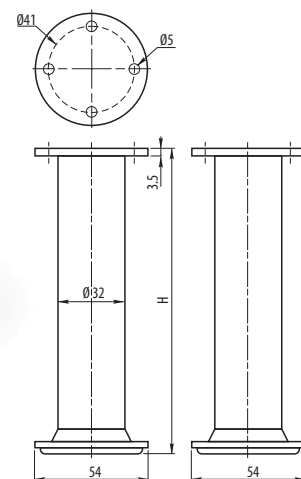

## Nózka 3023

Leg 3023 / Ножка 3023

Index: NM-XH3023-05



ZnAl



color

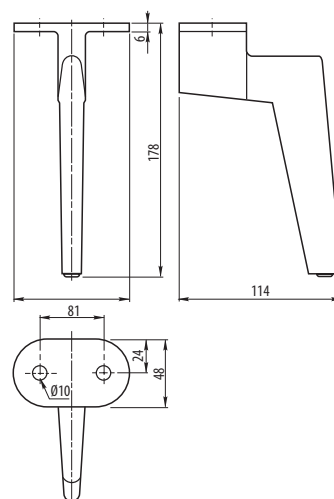

## Nóżka 3058

Leg 3058 / Ножка 3058

Index: NM-XH3058-01



material

aluminium / алюминий



color

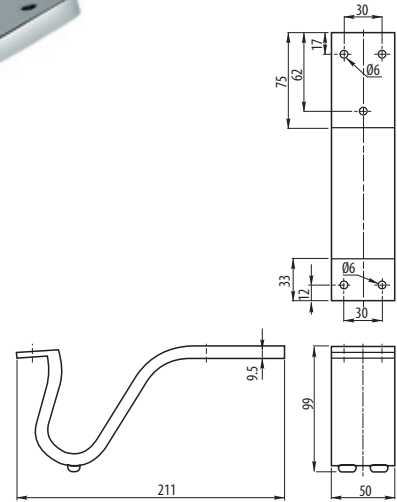

## Nóżka 3065

Leg 3065 / Ножка 3065

Index: NM-XH3065-05



material

aluminium / алюминий



color

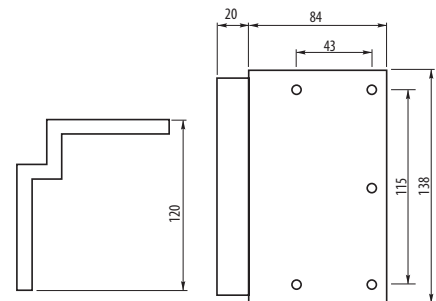
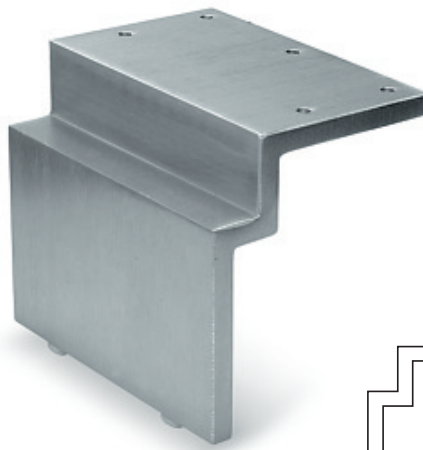

## Nóżka 3079

Leg 3079 / Ножка 3079

Index: NM-XH3079-01



material

stal / steel / сталь



color

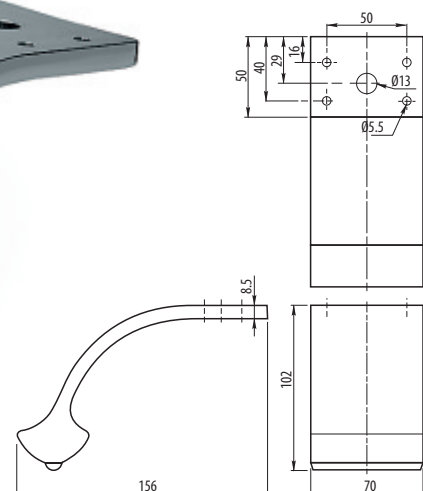

## Nóżka 3094

Index: NM-XH3094-01

Leg 3094 / Ножка 3094



stal / steel / сталь

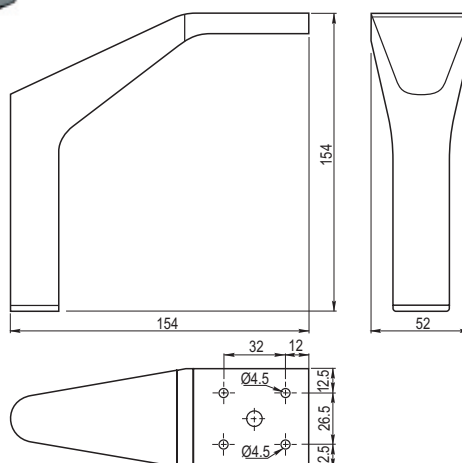

## Nóżka 8273

Index: NM-XH8273-01

Leg 8273 / Ножка 8273



aluminium / алюминий

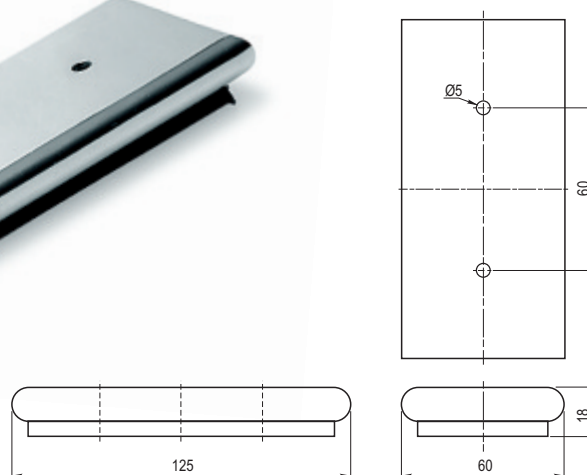

## Nóżka SF02

Index: NM-BDSF02-100

Leg SF02 / Ножка SF02

Cechy produktu / Features / Характеристика товара:

- nóżka z regulacją / adjustable leg / ножка с регулировкой



stal + porcelana / steel + porcelain  
сталь + фарфор

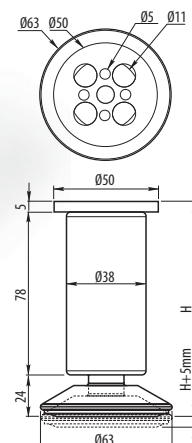

## Nóżka DAK

Leg DAK / Ножка DAK

Index: NM-DAK27-...  
(H)

### Cechy produktu / Features / Характеристика товара:

- nóżka z regulacją / adjustable leg / ножка с регулировкой



plastik / plastic / пластмасса



color



H 60 100 150

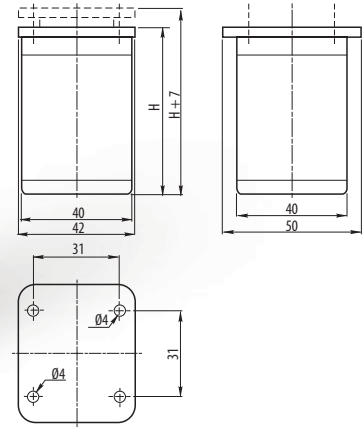

## Nóżka DAP

Leg DAP / Ножка DAP

Index: NM-DAP77-...  
(H)

### Cechy produktu / Features / Характеристика товара:

- nóżka z regulacją / adjustable leg / ножка с регулировкой



plastik / plastic / пластмасса



color



H 60 100 150

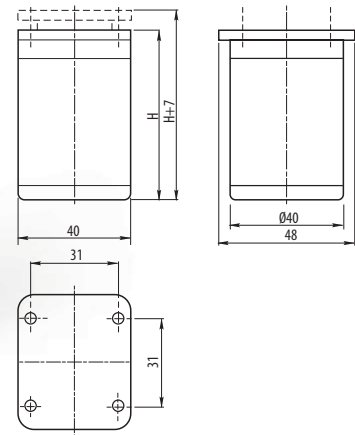

## Nóżka DPD

Leg DPD / Ножка DPD

Index: NM-DPD20-...  
(H)

### Cechy produktu / Features / Характеристика товара:

- nóżka z regulacją / adjustable leg / ножка с регулировкой
- maksymalne obciążenie 60 kg / max allowed load 60 kg
- максимальная нагрузка 60 кг



plastik / plastic / пластмасса



color

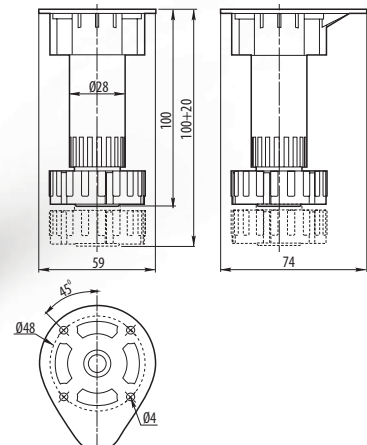

## Klip do nóżki

Plinth clip / Клипса к ножке

Index: NM-KL-DPL-20

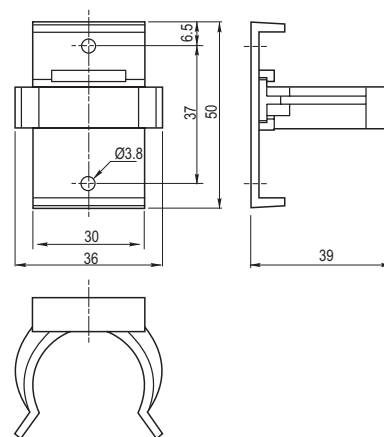

material

plastik / plastic / пластмасса



color

## Nóżka (ślizgacz meblowy) WPJ

Leg – furniture slider / Ножка пластиковая

Index: NM-WPJ22-D20

Cechy produktu / Features / Характеристика товара:

- Nóżka z regulacją / Adjustable leg / Ножка с регулировкой

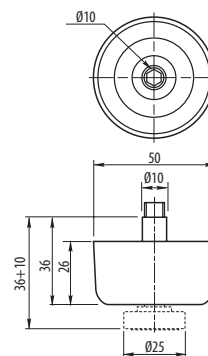

material

plastik / plastic / пластмасса



color

## Stopka meblowa D24 z nakrętką

Furniture foot with nut / Мебельная опора с муфтой

Index: SM-D249M6REG\*, SM-M6NAK-000\*\*

Cechy produktu / Features / Характеристика товара:

- \*stopka meblowa D24x9 / furniture foot D24x9 / Мебельная опора D24x9
- \*\*nakrętka wbijana M6x24 z ząbkami / nut M6x24 / с муфтой M6x24

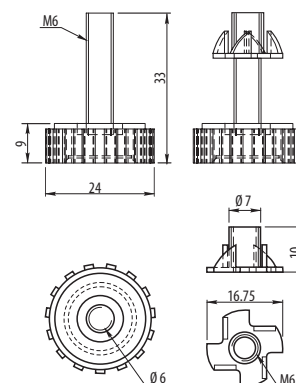

material

stal + plastik / steel + plastik  
сталь / пластмасса



color

# Noga meblowa kwadratowa

Square shaped furniture leg / Квадратная мебельная опора

Index: NM-46K710-05

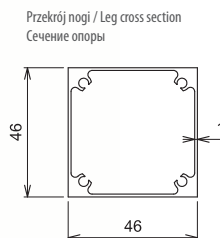
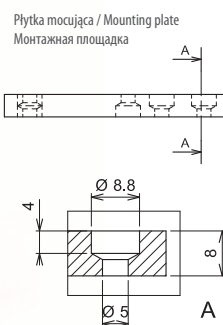
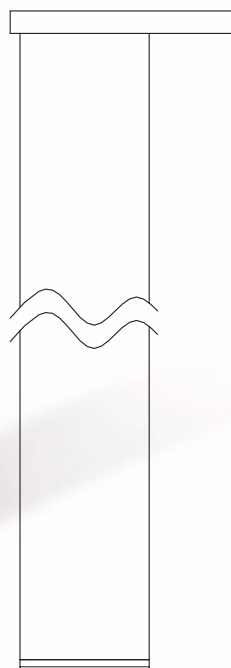
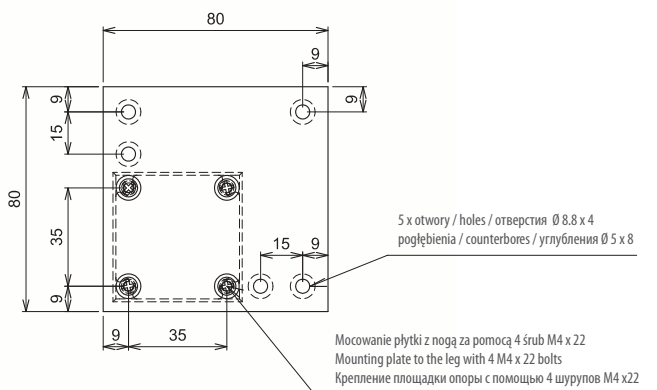

material

aluminium / алюминий



color



size

H 710

## Noga meblowa z mocowaniem skrzydełkowym

Index: NM-60....-..  
(H) (color)

Furniture leg with butterfly mounting / Мебельная опора с креплением «усы»

### Cechy produktu / Features / Характеристика товара:

- noga z regulacją / adjustable leg / опора с регулировкой

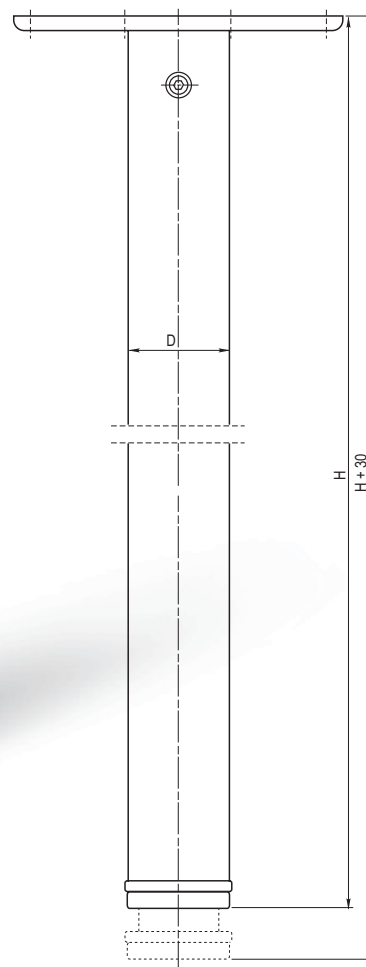
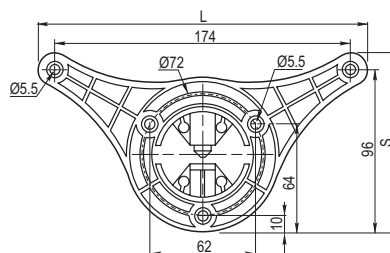

stal / steel / сталь



H 710 820 1100

# Noga meblowa z mocowaniem DRT09

Furniture leg with DRT09 mounting / Мебельная опора с креплением DRT09

Index: NM-P6....-...  
(H) (color)

## Cechy produktu / Features / Характеристика товара:

- noga z regulacją / adjustable leg / опора с регулировкой

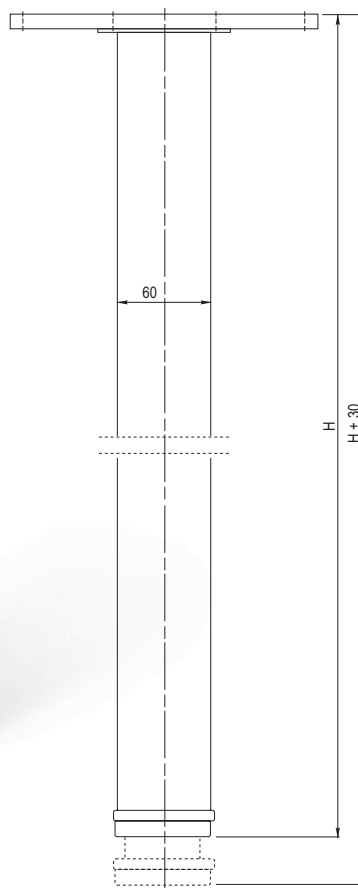
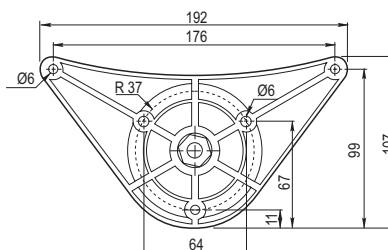
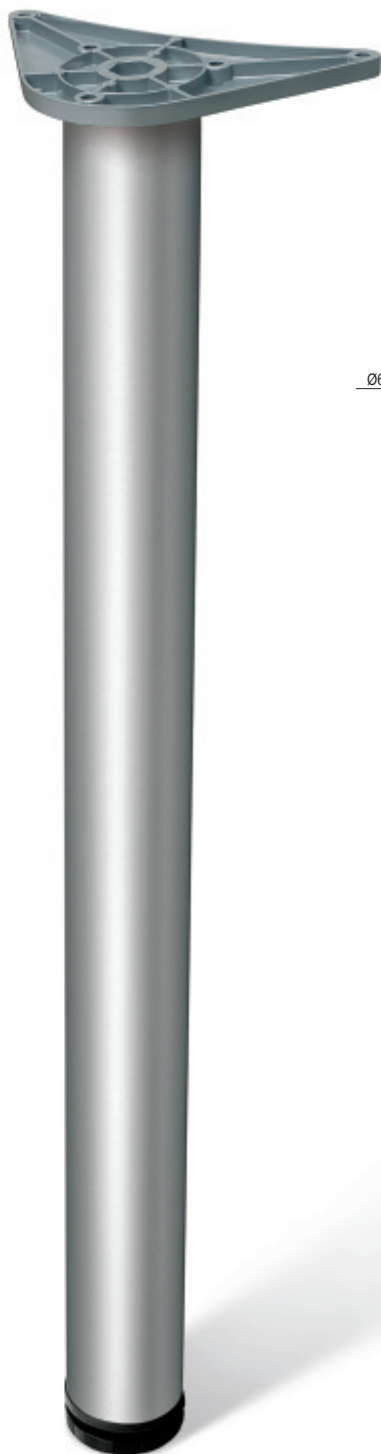

stal + aluminium / steel + aluminium  
сталь + алюминий



H 710 820 1100

## Rolki meblowe plastikowe

Furniture castors with plastic ball bearings / Пластиковые мебельные колёсики

Index: KM-015030-..., KM-015038-..  
(color) (color)

### Cechy produktu / Features / Характеристика товара:

- dostępne dwie wielkości:  $\varnothing$  30 i  $\varnothing$  38  
two sizes available: diam. 30 and diam. 38
- доступны в двух размерах диаметром 30 и 38 мм



plastik / plastic / пластмасса



color

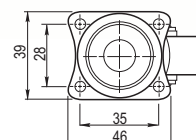
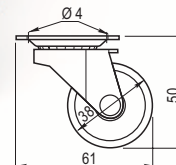
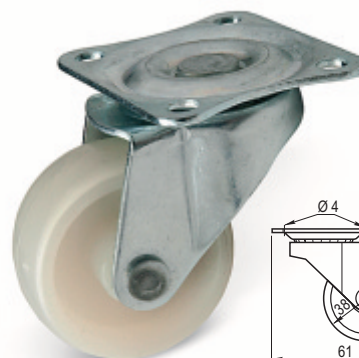
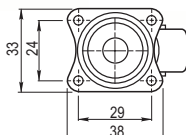
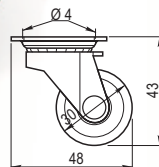
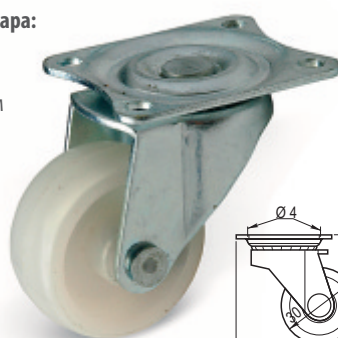

## Rolki meblowe przezroczyste 35 mm

Furniture castors (transparent) 35 mm / Мебельные колёсики прозрачные 35 мм

Index: KM-AH35MM-00, KM-A035MM-00

### Cechy produktu / Features / Характеристика товара:

- dostępne dwie wersje: z hamulcem i bez hamulca  
two versions available: with and without break
- доступны две версии - с тормозом и без тормоза
- maksymalne obciążenie 25 kg / max allowed load 25 kg  
максимальная нагрузка 25 кг
- łożyskowane / bearing furniture castor  
колесико на подшипнике



PC/PV

material

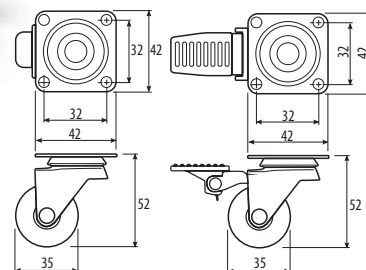

## Rolki meblowe przezroczyste 50 mm

Furniture castors (transparent) 50 mm / Мебельные колёсики прозрачные 50 мм

Index: KM-AH50MM-00, KM-A050MM-00

### Cechy produktu / Features / Характеристика товара:

- dostępne dwie wersje: z hamulcem i bez hamulca  
two versions available: with and without break
- доступны две версии - с тормозом и без тормоза
- maksymalne obciążenie 35 kg / max allowed load 35 kg  
максимальная нагрузка 35 кг
- łożyskowane / bearing furniture castor  
колесико на подшипнике



PC/PV

material

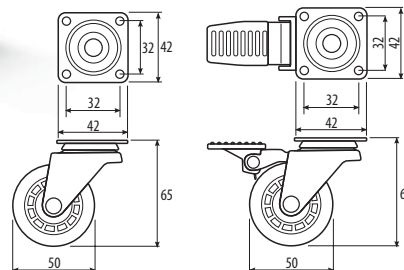

## Rolka meblowa standardowa

Furniture castors / Мебельные колёсики

Index: KM-00-...-D20, KM-0H-...-D20  
(0) (0)

### Cechy produktu / Features / Характеристика товара:

- dostępne dwie wersje: z hamulcem i bez hamulca  
two versions available: with and without break  
доступны две версии - с тормозом и без тормоза
- maksymalne obciążenie 35 kg / max allowed load 35 kg  
максимальная нагрузка 35 кг
- łożyskowane / bearing furniture castor  
колёсико на подшипнике

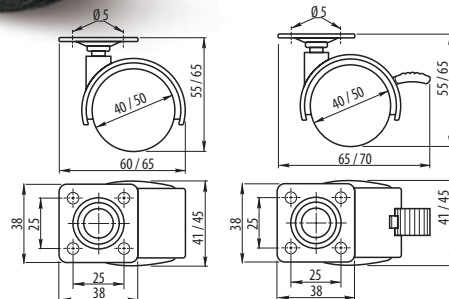

material

plastik / plastic / пластмасса



color



Pokrycia galwaniczne / Galvanic coatings  
Шаблон гальванических покрытий

- 01  chrom / chrome / хром
- 02  satyna / satin / сатин
- 03  mosiądz / brass / золото
- 04  stary mosiądz / antique brass / старое золото
- 05  aluminium / алюминий
- 06  stal szcziotkowana / brushed steel / шлифованная сталь

Pokrycia lakiernicze / Enamel coatings  
Шаблон лакированных покрытий

- 10  biały / white / белый
- 20  czarny / black / чёрный

Index	Strona / Page / Страница	Index	Strona / Page / Страница	Index	Strona / Page / Страница	Index	Strona / Page / Страница
GP-0728-I4-	30	NM-XH3065-05	49	UM-KID-D-001	33	UZ-605032-..	8
GP-0728-J4-	30	NM-XH3079-01	49	UM-KID-E-001	33	UZ-682...-06	8
GP-WP0727-P.	30	NM-XH3094-01	50	UM-KID-F-001	33	UZ-752...-06	8
GZ-WP0943-..	36	NM-XH8273-01	50	UM-KRASN-001	33	UZ-804064-..	9
GZ-WP0955-..	36	RS.....-..	23	UM-KRASN-002	33	UZ-814...-..	9
GZ-WP1136-04	36	SM-D249M6REG	52	UM-KRASN-003	33	UZ-819...-..	9
GZ-WP1148-04	37	SM-M6NAK-000	52	UM-KRASN-004	33	UZ-870...-..	10
GZ-WP1152-04	37	UA-00-313...	14	UM-KRASN-005	33	UZ-872224-..	10
GZ-WP1153-..	37	UA-00-314...	14	UM-KRASN-006	33	UZ-880016-..	10
GZ-WP1154-..	38	UA-00-315...	15	UM-KRASN-007	33	UZ-883016-..	11
GZ-WP1155-..	38	UA-00-316...	15	UM-WP00-A-00	32	UZ-888...-A1	28
GZ-WP1241-04	38	UA-00-319...	16	UM-WP00-B-00	32	UZ-888000-B1	28
GZ-ZH-011-..	39	UA-00-322...	16	UM-WP00-C-00	32	UZ-888032-C1	28
KM-00-...D20	57	UA-00-326...	16	UM-WP00-D-00	32	UZ-888032-D1	29
KM-0H-...D20	57	UA-00-330...	17	UM-WP00-E-00	32	UZ-888...-E1	29
KM-015030-..	56	UA-00-333...	17	UM-WP00-F-00	32	UZ-ETI064-04	26
KM-015038-..	56	UA-00-337...	18	UM-WP00-G-00	32	UZ-ETI096-04	26
KM-A035MM-00	56	UA-00-338...	18	UM-WP00-H-00	32	UZ-LILG01-04	26
KM-A050MM-00	56	UA-00-340...	18	UM-WP00-I-00	32	UZ-LIL064-04	26
KM-AH35MM-00	56	UA-00-341...	19	UM-WP00-J-00	32	UZ-LIL096-04	26
KM-AH50MM-00	56	UA-00-347...	19	UM-WP00-K-00	32	UZ-LONG01-04	25
KT-WP1147-..	39	UA-00-356...	19	UP-WP0727-P.	31	UZ-LON064-04	25
KT-WP1244-..	39	UA-00-358...	20	UP-SP0728-B.	31	UZ-LON096-04	25
NM-46K710-05	53	UA-00-380...	20	UP-WP0728-P.	31	UZ-NICG01-04	25
NM-60....-..	54	UA-00-385...	20	US-P60...-..	35	UZ-NIC064-04	25
NM-BD-001-..	44	UA-00-387...	21	US-P100...-..	35	UZ-NIC096-04	25
NM-BD-003-..	44	UA-01-326...	16	US-P500...-..	34	UZ-RENG01-04	27
NM-BD-100-..	44	UA-18-.....	13	US-P700...-..	34	UZ-RENG02-04	27
NM-BD-150-..	44	UA--326...-..	17	US-SKN...-06	24	UZ-REN064-04	27
NM-BD-712-..	45	UA-72H...-01	13	US-SKO...-06	24	UZ-REN096-04	27
NM-BD-712-M1	45	UA-79F...-..	13	UZ-00B224-..	1	UZ-W20...-..	11
NM-BD-726-..	45	UA-709...-..	21	UZ-00B226-..	1	UZ-WP1146-04	11
NM-BD727-...	45	UA-A18...-..	13	UZ-01-...-..	2	UZ-WP1192-01	12
NM-BD-734-..	46	UA-A19...06	23	UZ-04-...-..	2	UZ-Z08128-..	12
NM-BD-739-05	46	UA-A3...-06	21	UZ-05-...-..	2	UZ-Z10...-...	12
NM-BD-741-05	46	UA-A4...-06	22	UZ-06-128-..	3	WZ-00-K24-..	40
NM-BD-762-..	47	UA-A6-...-06	22	UZ-07-096-..	3	WZ-A0-K23..	43
NM-BD-780-..	47	UA-A7-...-06	22	UZ-10-096-N04	3	WZ-A0-K24-..	43
NM-BD-783-..	47	UA-AA-03-...	21	UZ-12-096-04	24	WZ-B0-K23..	43
NM-BD867-100	48	UA-AA-04-...	22	UZ-13-096-..	4	WZ-B0-K24-..	43
NM-BD868-...	48	UA-AA-06-...	22	UZ-14-...-..	4	WZ-C0-K24-..	42
NM-BD869-150	48	UA-AA-07-...	22	UZ-19-032-..	4	WZ-D-070-..	40
NM-BDSF02-100	50	UA-AA-114-..	1	UZ-40-032-..	5	WZ-D-110-..	41
NM-DAK27-...	51	UA-B0-311...	14	UZ-55-025-..	5	WZ-D-117-..	41
NM-DAP77-...	51	UA-B0-337...	23	UZ-60-032-..	5	WZ-D-138-..	41
NM-DPD20-..	51	UA-B311.....	14	UZ-64F...-01	6	WZ-D-892-..	42
NM-KL-DPL-20	52	UA-B337...06	23	UZ-71-...-..	6	WZ-D-956-..	42
NM-P6....-..	55	UA-D316...-06	15	UZ-92-...-..	6	WZ-E-018-..	40
NM-WPJ22-D20	52	UM-KID-A-001	33	UZ-334...-06	7		
NM-XH3023-05	48	UM-KID-B-001	33	UZ-335...-06	7		
NM-XH3058-01	49	UM-KID-C-001	33	UZ-336...-06	7		

WWW.GTV.COM.PL

**GTV**

*ul. Przejazdowa 21  
05-800 Pruszków  
Poland*

*tel. + 48 22 444 75 00  
fax + 48 22 444 75 01  
mail: info@werkpol.pl*

*www.gtv.com.pl*

## Zamek kwadratowy 138

Square lock 138 / Квадратный замок 138

Index: ZZ-KM-138-01

material  
stal + ZnAl  
steel + ZnAl  
сталь + ZnAl

color

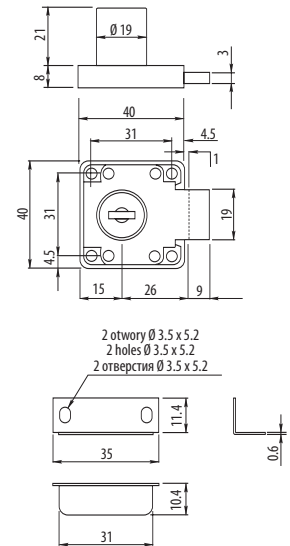

## Zamek kwadratowy 138 + klucz cyfrowy

Square lock 138 + digital key / Квадратный замок 138 с цифровым ключем

Index: ZZ-CF-138-01, ZZ-KLMASTER\*, ZZ-KLREMOVAL\*\*

### Cechy produktu / Features / Характеристика товара:

- zamek z kluczem cyfrowym / lock with digital key / замок с цифровым ключем
- osobno w sprzedaży także klucz matka\* i klucz do wymiany bębenków\*\*  
master key\* and key for replacement of cylinders\*\* on sale separately as well  
тдельно в продаже также ключ «матка»\* и ключ для смены вкладышей\*\*

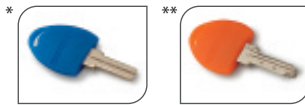

material  
stal + ZnAl  
steel + ZnAl  
сталь + ZnAl

color

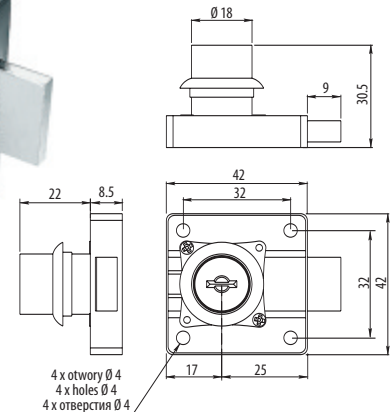

## Zamek kwadratowy 138 + klucz łamany

Square lock 138 + break key / Квадратный замок с ломаным ключем

Index: ZZ-ZN-138-01

### Cechy produktu / Features / Характеристика товара:

- zamek z kluczem łamany  
lock with break key  
ЗАМОК С ЛОМАНЫМ КЛЮЧЕМ

material  
stal + ZnAl  
steel + ZnAl  
сталь + ZnAl

color

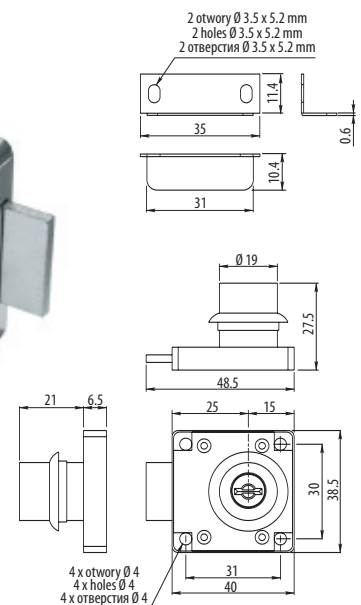

## Zamek kwadratowy zatraskowy 338

Square lock 338 / Замок с защёлкой 338

Index: ZZ-ZN-338-01



stal + ZnAl  
steel + ZnAl  
сталь + ZnAl

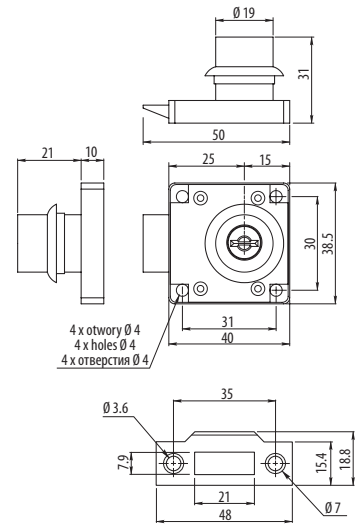

## Zamek bolcowy

Pin lock / Замок кнопочный для раздвижных дверей

Index: ZZ-B0-105-01



stal + ZnAl  
steel + ZnAl  
сталь + ZnAl

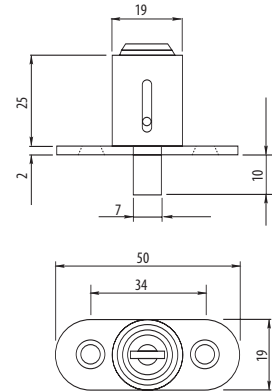

## Zamek skrzynkowy

Box lock / Замок для ящика

Index: ZZ-.-103-01  
(model)



stal + ZnAl  
steel + ZnAl  
сталь + ZnAl

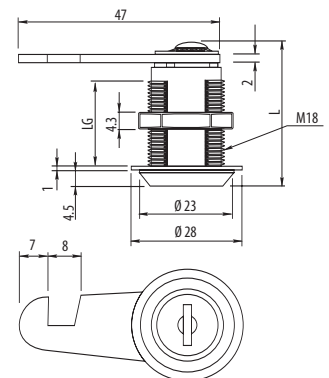

L	28 mm	32 mm	41 mm
LG	14 mm	17.5 mm	28.5 mm
Model	16	20	30

## Zamek do szyb 407

Glass door lock 407 / Замок для стеклянной распашной двери 407

Index: ZZ-SZ-407-..  
(color)

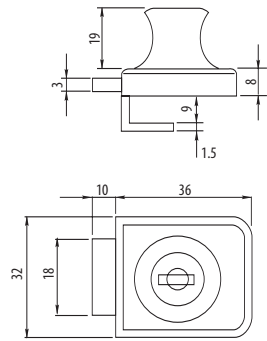
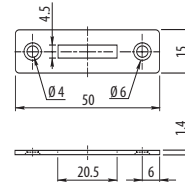

## Zamek do szyb 408

Glass door lock 408 / Замок для двух распашных стеклянных дверей 408

Index: ZZ-SZ-408-..  
(color)

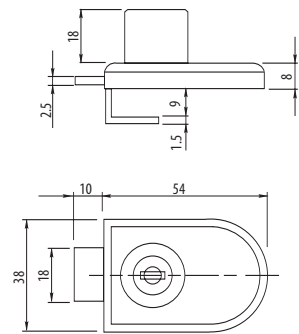
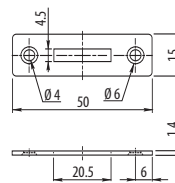

## Zamek do szyb 409

Glass door lock 409 / Замок для двух распашных стеклянных дверей 409

Index: ZZ-SZ-409-..  
(color)

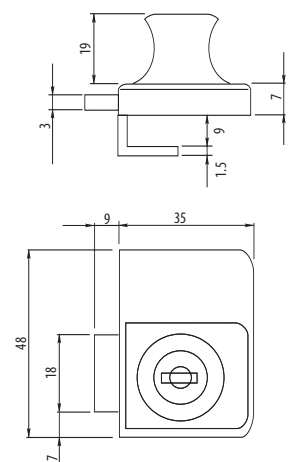
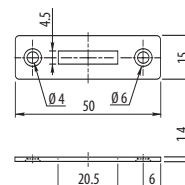

## Zamek meblowy

Furniture lock / Замок мебельный

Index: ZZ-M0-201-01

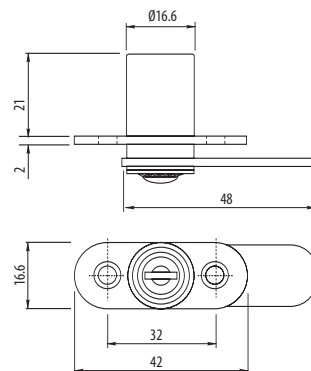

stal + ZnAl  
steel + ZnAl  
сталь + ZnAl



## Zamek żaluzjowy

Blinds lock / Замок для жалюзи

Index: ZZ-Z0-202-01

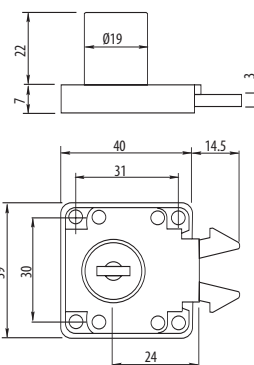
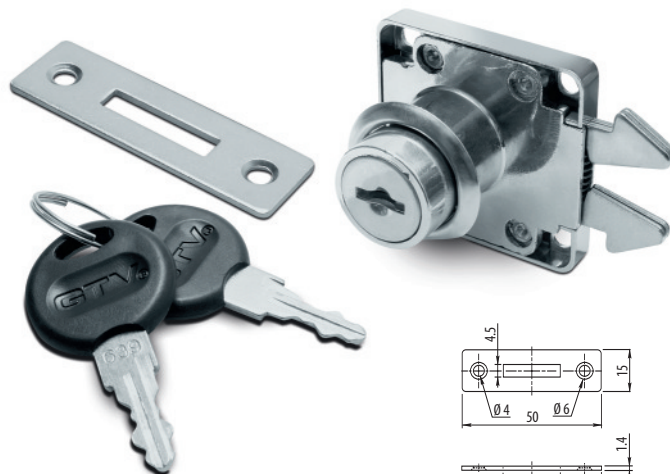

stal + ZnAl  
steel + ZnAl  
сталь + ZnAl



## Zamek grzbietowy

Glass sliding lock / Замок внутренний

Index: ZZ-G0-328-01

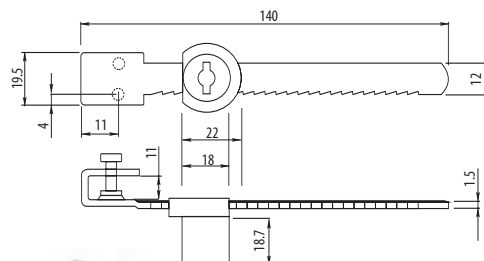

stal + ZnAl  
steel + ZnAl  
сталь + ZnAl



# Zamek baskwiliowy

Casement, bar lock / Замок шпингалетный

Index: ZZ-BA-SK0-01

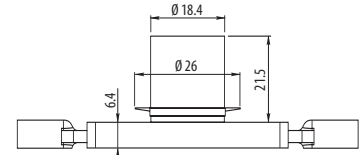
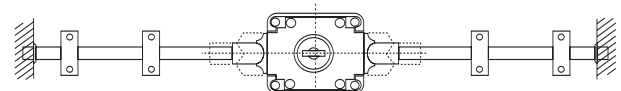

Wysuw po zamknięciu = 100 mm  
Extension after the close = 100 mm  
Выдвижение после закрытия = 100 mm

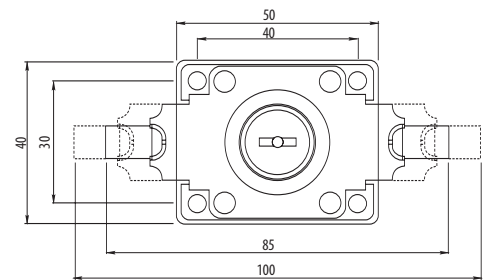

material  
stal + ZnAl  
steel + ZnAl  
сталь + ZnAl



x4

# Zamek centralny

Central lock / Замок центральный боковой

Index: ZZ-C.-288-01  
(model)

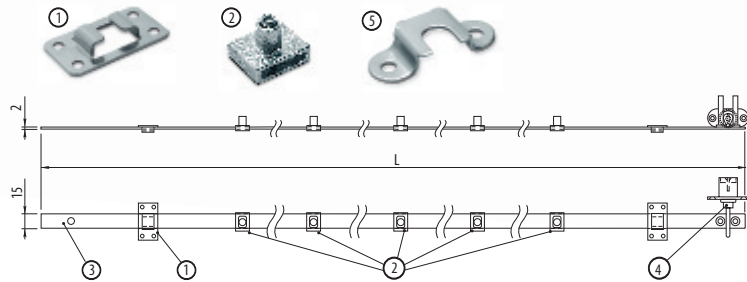
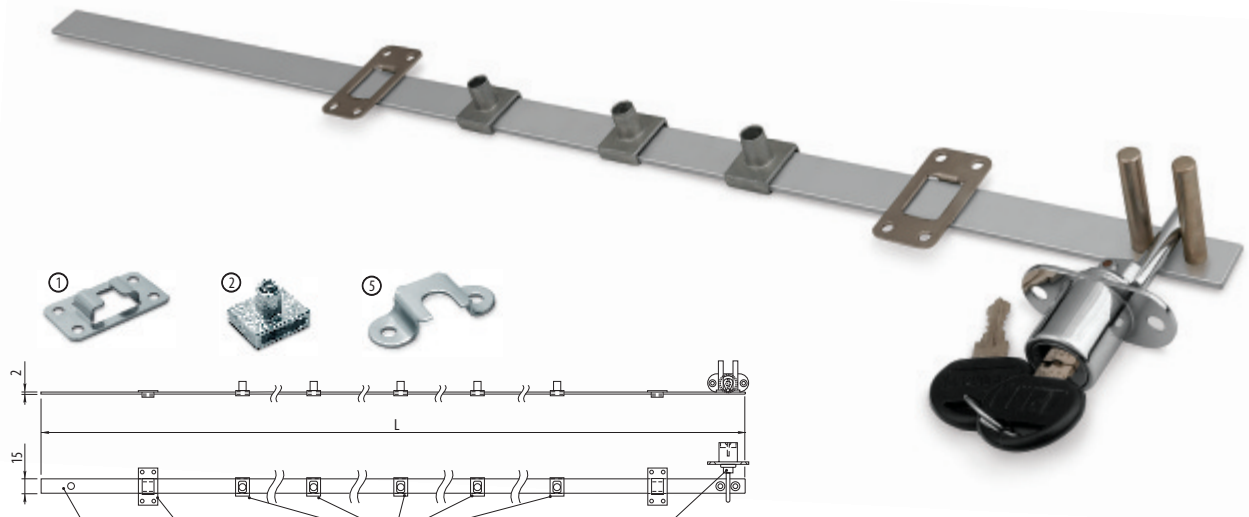

Skład zestawu: / Set includes: / Состав набора:

- ① Mocowanie listwy (2 szt.) / slot fixing (2 pcs.) / крепление планки 2 шт.
- ② Blokada szuflady ("N" szt.) / drawer locking mechanism (N.pcs.) / блокада ящика (N. шт.)
- ③ Listwa zamka / lock slot / планка замка
- ④ Zamek / lock / замок
- ⑤ Zaczep ("N" szt.) / hook (N.pcs.) / зацепка (N. шт.)

N	3	3	4	4
L (mm)	500	600	800	1200
model:	C5	C6	C8	C1

material  
ZnAl / steel

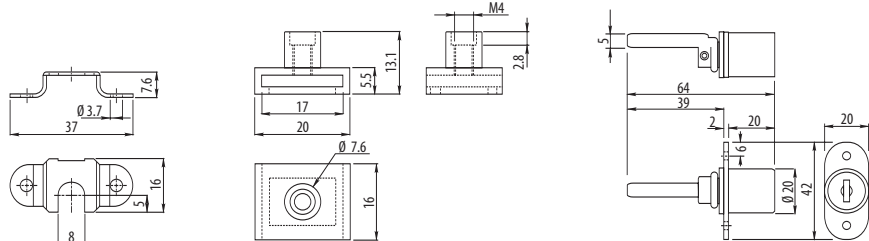

## PELIKAN - podpora do półek (mini)

Shelf support PELIKAN (mini) / Полкодержатель PELIKAN

Index: PP-XS0045-...  
(color)

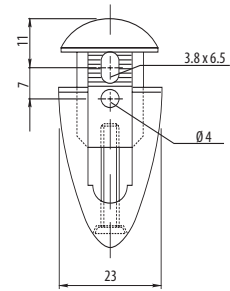
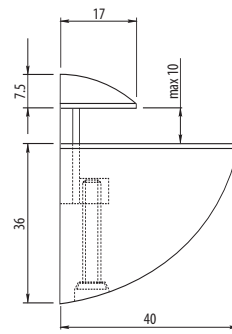

ZnAl

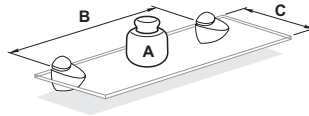

A - max obciążenie 5 kg / max. load 5 kg / максимальная нагрузка 5 кг  
 B - odległość między podórkami 25 cm / distance between supports 25 cm / расстояние между полкодержателями 25 см  
 C - głębokość półki 15 cm / shelf depth 15 cm / глубина полки 15 см

\* Maksymalne obciążenie zależy od ilości wsporników i materiału z jakiego wykonana jest półka

\* The maximum load depends on the number of supports and material of which the shelf is made

\* Максимальная нагрузка зависит от количества кронштейнов и материала, из которого изготовлена полка

## PELIKAN - podpora do półek (mała)

Shelf support PELIKAN (small) / Полкодержатель PELIKAN

Index: PP-MPO55-...  
(color)

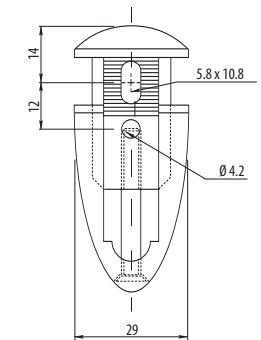
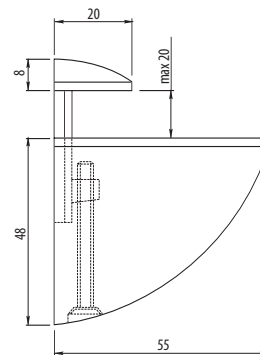

ZnAl

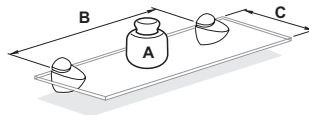

A - max obciążenie 8 kg / max. load 8 kg / максимальная нагрузка 8 кг  
 B - odległość między podórkami 40 cm / distance between supports 40 cm / расстояние между полкодержателями 40 см  
 C - głębokość półki 20 cm / shelf depth 20 cm / глубина полки 20 см

\* Maksymalne obciążenie zależy od ilości wsporników i materiału z jakiego wykonana jest półka

\* The maximum load depends on the number of supports and material of which the shelf is made

\* Максимальная нагрузка зависит от количества кронштейнов и материала, из которого изготовлена полка

## PELIKAN - podpora do półek (średnia)

Shelf support PELIKAN (medium) / Полкодержатель PELIKAN

Index: PP-SP0075-...  
(color)

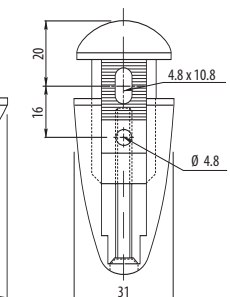
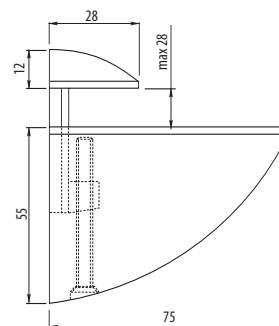

ZnAl

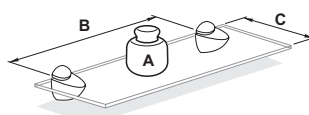

A - max obciążenie 10 kg / max. load 10 kg / максимальная нагрузка 10 кг  
 B - odległość między podórkami 50 cm / distance between supports 50 cm / расстояние между полкодержателями 50 см  
 C - głębokość półki 25 cm / shelf depth 25 cm / глубина полки 25 см

\* Maksymalne obciążenie zależy od ilości wsporników i materiału z jakiego wykonana jest półka

\* The maximum load depends on the number of supports and material of which the shelf is made

\* Максимальная нагрузка зависит от количества кронштейнов и материала, из которого изготовлена полка

## PELIKAN - podpora do półek (duża)

Shelf support PELIKAN (large) / Полкодержатель PELIKAN

Index: PP-DP0105--  
(color)

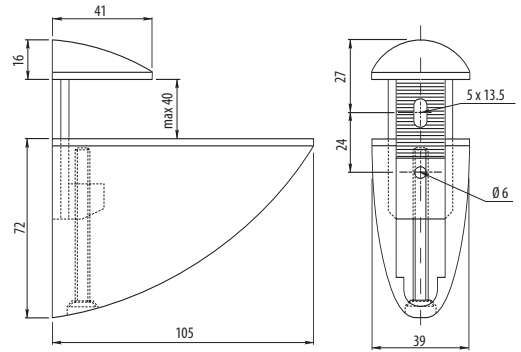

ZnAl

material



color

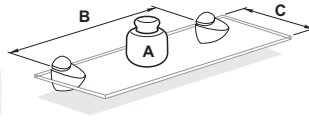

A - max obciążenie 12 kg / max. load 12 kg / максимальная нагрузка 12 кг

B - odległość między podprórkami 60 cm / distance between supports 60 cm / расстояние между полкодержателями 60 см

C - głębokość półki 30 cm / shelf depth 30 cm / глубина полки 30 см

\* Maksymalne obciążenie zależy od ilości wsporników i materiału z jakiego wykonana jest półka

\* The maximum load depends on the number of supports and material of which the shelf is made

\* Максимальная нагрузка зависит от количества кронштейнов и материала, из которого изготовлена полка

## PELIKAN NEW DESIGN - podpora do półek (mała)

Shelf support NEW DESIGN (small) / Полкодержатель NEW DESIGN

Index: PP-DP0047--  
(color)

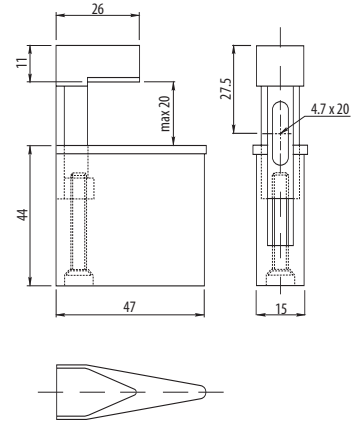

ZnAl

material



color

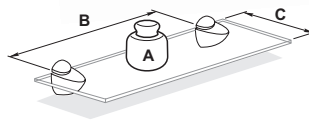

A - max obciążenie 5 kg / max. load 5 kg / максимальная нагрузка 5 кг

B - odległość między podprórkami 25 cm / distance between supports 25 cm / расстояние между полкодержателями 25 см

C - głębokość półki 15 cm / shelf depth 15 cm / глубина полки 15 см

\* Maksymalne obciążenie zależy od ilości wsporników i materiału z jakiego wykonana jest półka

\* The maximum load depends on the number of supports and material of which the shelf is made

\* Максимальная нагрузка зависит от количества кронштейнов и материала, из которого изготовлена полка

## PELIKAN NEW DESIGN - podpora do półek (średnia)

Shelf support NEW DESIGN (medium) / Полкодержатель NEW DESIGN

Index: PP-DP0066--  
(color)

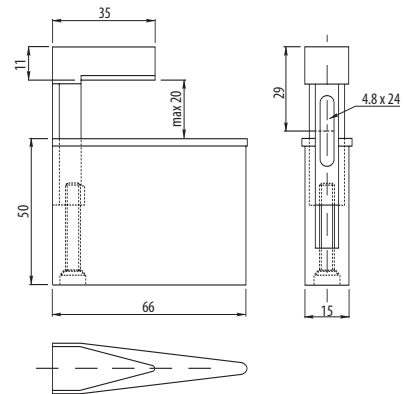

ZnAl

material



color

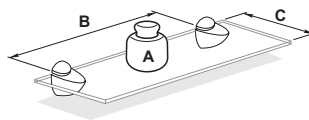

A - max obciążenie 8 kg / max. load 8 kg / максимальная нагрузка 8 кг

B - odległość między podprórkami 40 cm / distance between supports 40 cm / расстояние между полкодержателями 40 см

C - głębokość półki 20 cm / shelf depth 20 cm / глубина полки 20 см

\* Maksymalne obciążenie zależy od ilości wsporników i materiału z jakiego wykonana jest półka

\* The maximum load depends on the number of supports and material of which the shelf is made

\* Максимальная нагрузка зависит от количества кронштейнов и материала, из которого изготовлена полка

## PELIKAN NEW DESIGN - podpora do półek (duża)

Shelf support NEW DESIGN (large) / Полкодержатель NEW DESIGN

Index: PP-DP0097-..  
(color)

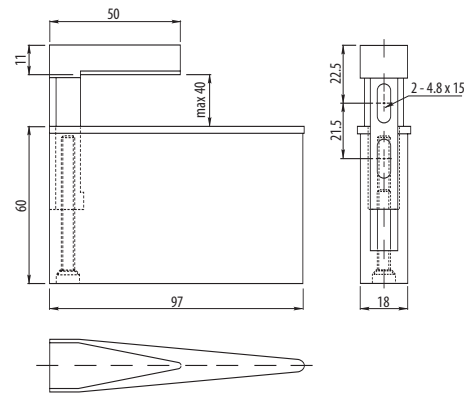

ZnAl

material



color

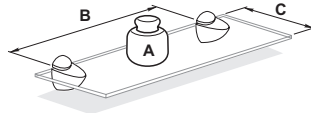

A - max obciążenie 10 kg / max. load 10 kg / максимальная нагрузка 10 кг

B - odległość między podprórkami 50 cm / distance between supports 50 cm / расстояние между полкодержателями 50 см

C - głębokość półki 25 cm / shelf depth 25 cm / глубина полки 25 см

\* Maksymalne obciążenie zależy od ilości wsporników i materiału z jakiego wykonana jest półka

\* The maximum load depends on the number of supports and material of which the shelf is made

\* Максимальная нагрузка зависит от количества кронштейнов и материала, из которого изготовлена полка

## Podpora GS01 do półek

Shelf support GS01 / Полкодержатель GS01

Index: PP-00GS01-..  
(color)



ZnAl

material



color

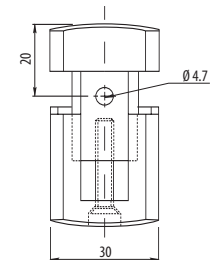
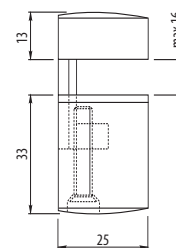

## Podpora GS02 do półek

Shelf support GS02 / Полкодержатель GS02

Index: PP-00GS02-..  
(color)



ZnAl

material



color

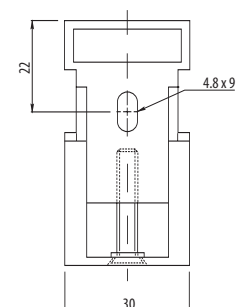
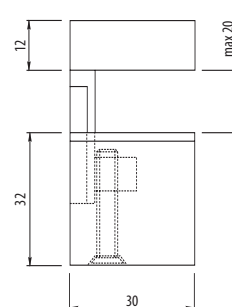

## Podpórka GS03 do półek

Shelf support GS03 / Полкодержатель GS03

Index: PP-00GS03-...  
(color)



ZnAl

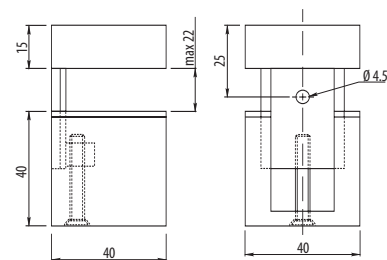

## Podpórka GS04 do półek

Shelf support GS04 / Полкодержатель GS04

Index: PP-00GS04-...  
(color)



ZnAl

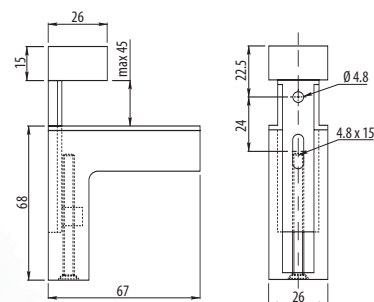

## Podpórka do półek szklanych 2710

Glass shelf support 2710 / Полкодержатель для стекла 2710

Index: PP-HS2710-...  
(color)



ZnAl

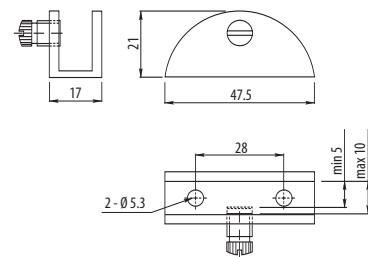

## Podpórka do półek szklanych 2713

Glass shelf support 2713 / Полкодержатель для стекла 2713

Index: PP-HS2713-...  
(color)



ZnAl

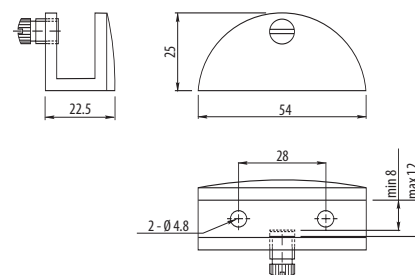

## Podpórka do półek szklanych

Index: PP-HS0006-01

Glass shelf support / Полкодержатель с резиновым кольцом для стекла

### Cechy produktu / Features / Характеристика товара:

- Grubość szkła max 5 mm  
Glass thickness, max. 5 mm  
Толщина стекла макс. 5 мм



ZnAl

material



color



01

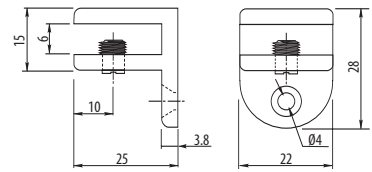

## Podpórka do półek szklanych

Index: PP-SOL012-01

Glass shelf support / Полкодержатели с присоской угловой

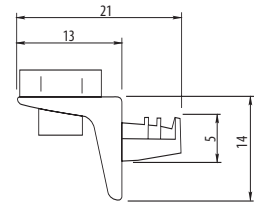

ZnAl + tworzywo  
ZnAl + plastic  
ZnAl + пластмасса

material

## Podpórka do półek z przyssawką

Index: PP-SOL003-01

Shelf suction cup / Полкодержатели с присоской прямой

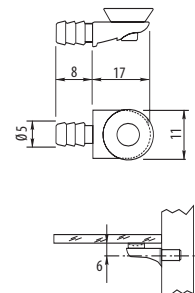

ZnAl + tworzywo  
ZnAl + plastic  
ZnAl + пластмасса

material

## DUPLO - podpórka do półek

Index: MR-TDL011-01, MR-ZSL011-01\*

Shelf pin DUPLO / Полкодержатель ДУПЛО

### Cechy produktu / Features / Характеристика товара:

- Dostępna także wersja z zaślepką L011\*  
Also available shelf support with cap L011\*  
Доступен вариант с заглушкой L011\*



stal / steel / сталь

material



color



01

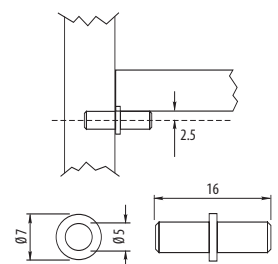

## SAFETY - podpora do półek

Shelf pin SAFETY / Полкодержатель металлопластиковый прозрачный SAFETY

Index: PP-SPL001-...  
(color)



stal + tworzywo  
steel + plastic  
сталь + пластмасса



color

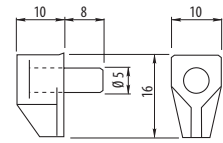

## SMART - podpora do półek

Shelf support SMART / Полкодержатель SMART

Index: PP-SMART-000

Cechy produktu / Features / Характеристика товара:

- Po zamontowaniu podpora jest niewidoczna  
Support is invisible after mounting
- После монтажа полокодержатель не заметен



stal / steel / сталь

material

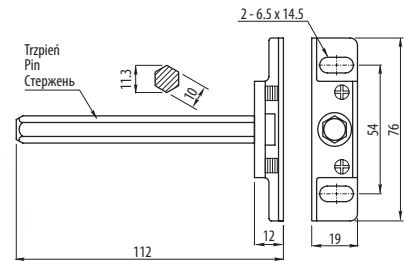

## Podpórki do półek WS

WS shelf bracket / Регименсоль WS

Index: WB-WS-...-0...  
(L) (color)



stal + tworzywo  
steel + plastic  
сталь + пластмасса



color



L = 12, 18, 24 cm

size

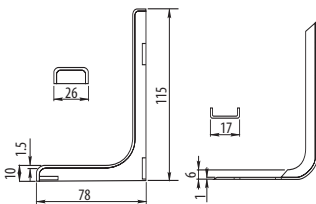

Oslona 12  
Cover 12  
Оболочка 12

Wspornik 12  
Support 12  
Кронштейн 12

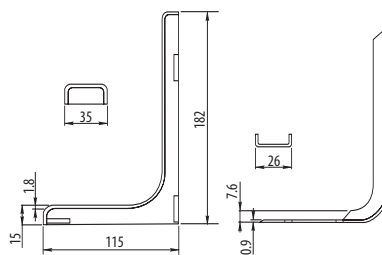

Oslona 18  
Cover 18  
Оболочка 18

Wspornik 18  
Support 18  
Кронштейн 18

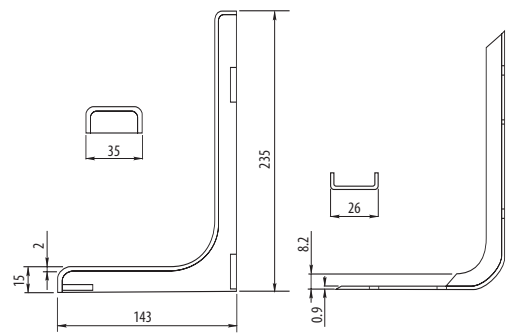

Oslona 24  
Cover 24  
Оболочка 24

Wspornik 24  
Support 24  
Кронштейн 24

## Wspornik budowlany ze wzmocnieniem

Shelf bracket / Регименсоль с уплотнителем

Index: WB-073024-...  
(color)

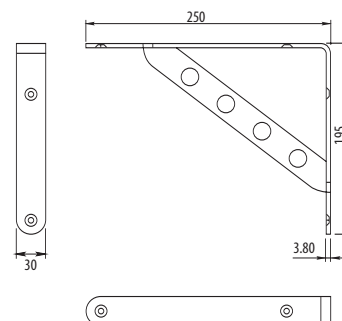

## Podpórka do półek ze wzmocnieniem łukowym

Shelf bracket / Регименсоль с уплотнителем

Index: PP-LUK-00...  
(color)

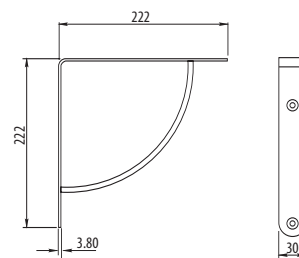

## Wspornik budowlany ze wzmocnieniem z wieszakiem

Shelf bracket / Регименсоль с уплотнителем

Index: WB-073026-...  
(color)

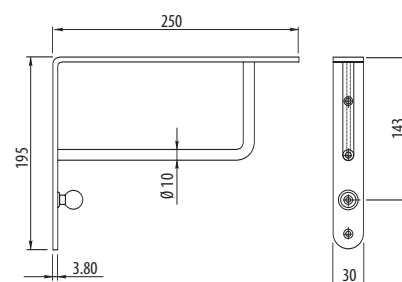

## Zawieszka kuchenna STRONG

Kitchen hanger STRONG / Навес кухонный STRONG

Index: ZK-STRONG-.1; ZK-ZAS-.0-10\*

(lewy) (prawy)  
(left) (right)  
(левый) (правый)

### Cechy produktu / Features / Характеристика товара:

- Zaślepki dostępne oddzielnie\*  
Caps available separately\*  
Заглушки доступны отдельно\*



stal + tworzywo  
steel + plastic  
сталь + пластмасса



color

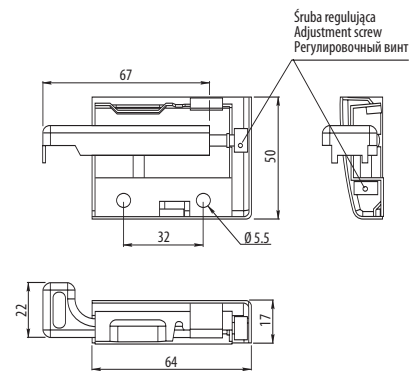
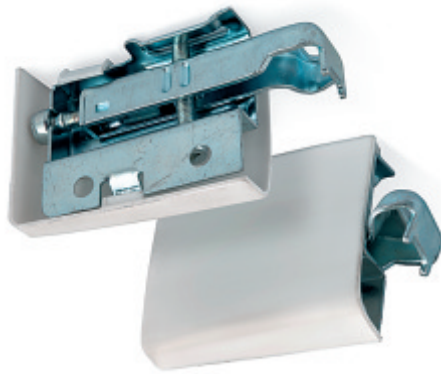

## Zawieszka kuchenna

Kitchen hanger / Навес кухонный

Index: ZK-R1-KPL-10



stal + tworzywo  
steel + plastic  
сталь + пластмасса



color

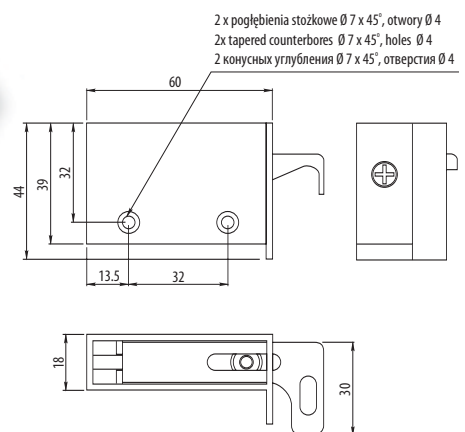

## Magnesy

Magnetic catches / Магниты

Index: MG-MENSA-0..  
(color)



stal + tworzywo  
steel + plastic  
сталь + пластмасса



color

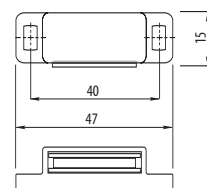

## Szybkozłącza

Fast connectors / Стяжки

Index: SZ-005-00-..., SZ-008-00-..  
(color) (color)



stal / steel / сталь

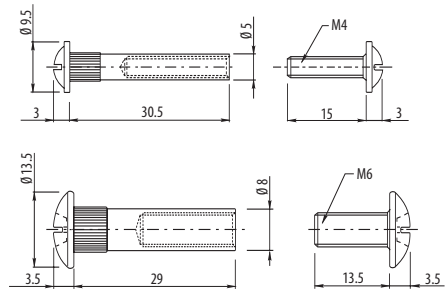

## Łącza do blatów

Concealed joiners / Стяжка для столешниц

Index: EM-SBL...-01  
(L)



stal + tworzywo  
steel + plastic  
сталь + пластмасса



L = 60, 65, 100, 150 mm

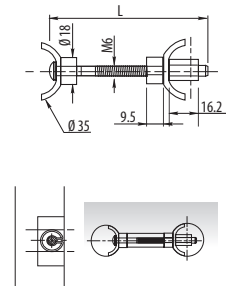
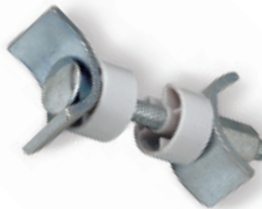

## Konfirmaty

Allan screws / Конфирмат

Index: WK-CF...-01  
(size)



stal / steel / сталь

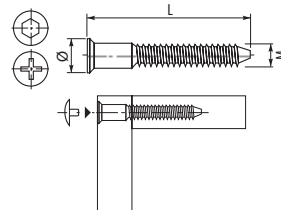

Ø	L	M
9,5	50	5
9,5	50	6,4
9,5	50	7
9,5	70	7

## Wkręty do drewna

Screws for wooden boards / Мебельные метизы

Index: WK-D0...-0..  
(size) (color)



stal / steel / сталь

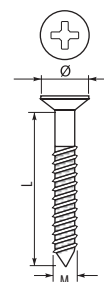

M	L	Ø
3	13	7
3	16	7
3	20	7
3	25	7
3,5	13	7
3,5	16	7
3,5	20	7
3,5	30	7
3,5	35	7
4	13	7
4	16	7
4	30	7
4	50	7

## Kątownik szeroki

Angle bracket / Широкий угольник

Index: KW-FS01..-01  
(L)



material

stal / steel / сталь



size

L = 25, 40 mm

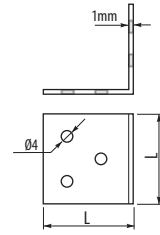

## Kątownik tłoczony wzmocniany

Angle bracket / Поршневой укрепленный угольник

Index: KW-FS03..-01  
(L)



material

stal / steel / сталь



size

L = 30, 35, 50, 75 mm

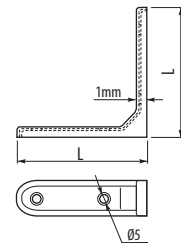

## Kątownik standardowy

Angle bracket / Стандартный угольник

Index: KW-FS04..-00  
(L)



material

stal / steel / сталь



size

L = 25x25, 30x30, 40x40, 50x50, 60x60, 75x75

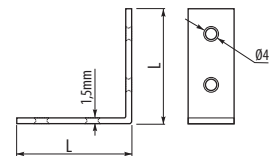

## Kątownik narożnikowy

Corner bracket / Угловой угольник

Index: KW-FS0650-01



material

stal / steel / сталь

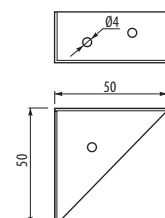

## Rura Ø 25

Index: RR-.....H..  
(Ø)(T)(L) (Color)

Round wardrobe bar fitted with black PVC cover plates / Мебельная штанга

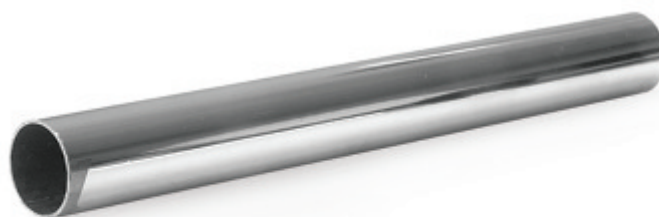

stal / steel / сталь

material



color



Dostępne grubości (T)  
Available thickness (T)  
Доступная толщина (T)

Dostępne długości (L)  
Available length (L)  
Доступные размеры длины (L)

Ø	Available thickness (T)	Available length (L)
16	1 / 1,2 mm	0,6 / 1 / 3 m
25	0,8 / 0,9 / 1 mm	3 m
32	1 mm	3 m
50	1 / 1,2 mm	3 m

## Drażek owalny

Index: RR-CH-OW-000

Oval wardrobe bar / Овальная труба для гардероба

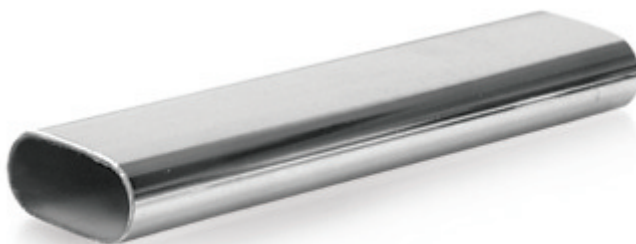

stal / steel / сталь

material



color



size

długość / length / длина: 3000 mm

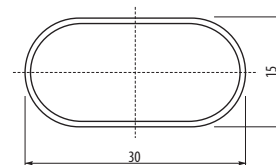

## Przedłużenie do rur z pierścieniem

Index: MR-TH014-001

Extension for pipes with ring / Длиннение для трубы с кольцом

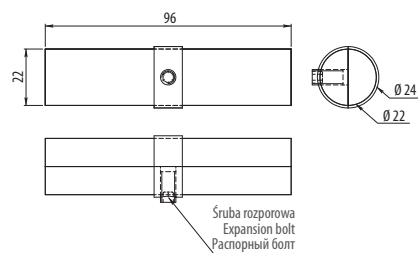

ZnAl

material



color



## Łącznik do rur

Fitting for pipes / Соединитель для трубы

Index: MR-WP013-001

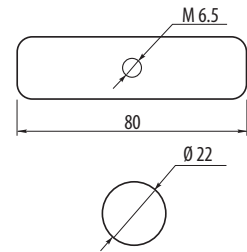

material

ZnAl



color

Ocynk / Zinc-plated / Оцинковка

## Złącze dwuramiennie proste

Simple two-arm connector / Муфта «S» замыкающая прямая

Index: MR-TH005-001

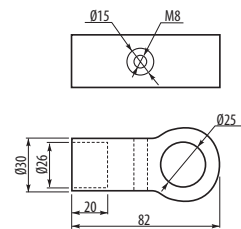

material

ZnAl



color



## Złączka typu T do rury Ø25

T-type connector for pipe / Муфта типа «Т» для трубы

Index: MR-TH004-001

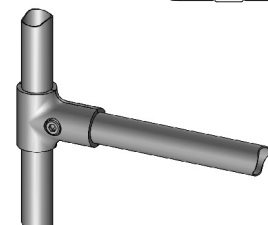
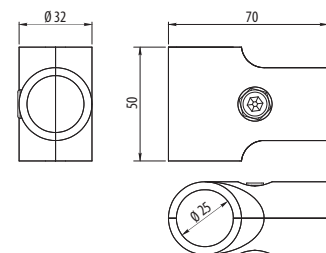

material

ZnAl



color



## Zestaw złączek typu T do rury Ø25

Set for T-type connectors for pipe / Муфта «S-T»

Index: MR-T1824-KPL

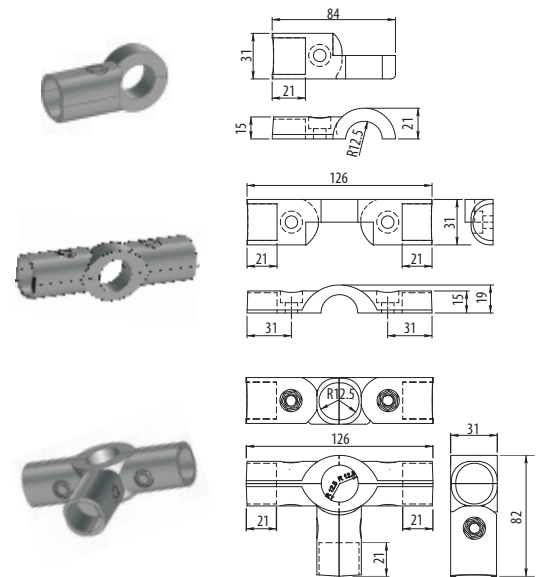

## Złączka końcowa mała

Little final connector / Муфта «S» замыкающая малая

Index: MR-TH016-001

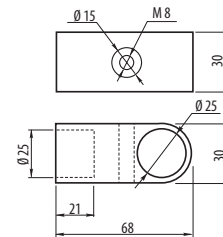

## Zestaw złączek typu S do rury Ø25

Set of S-type connectors for pipe / Муфта „S” угловая

Index: MR-TH018-KPL

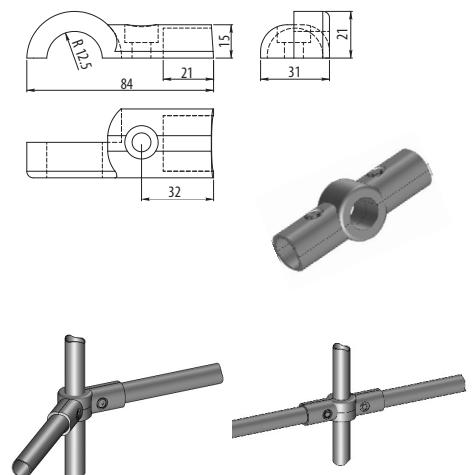

Możliwość uzyskania różnych położeń połączenia  
 The possibility of obtaining various positions of connection  
 Возможность получения разных положений соединения

## Złącze zawiasowe

Hinge connector / Муфта петлевая

Index: MR-TH011-001

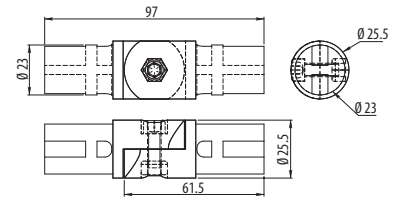

Możliwość dostosowania kąta ramion złączy do założonego położenia (do 180°)  
The possibility of adjustment of angle of connector arms to the assumed position (180°)  
Возможность регулировки угла плечей соединителей к заданному положению (180°)



ZnAl

material



color

## Złączka równoległa

Parallel connector / Муфта параллельная

Index: MR-TH001-001

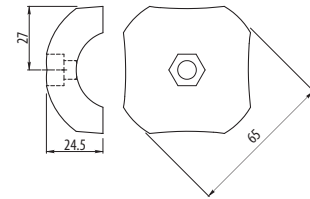

ZnAl

material



color

## Złączka potrójna z wcięciem do rury Ø25

Triple connector with cut for pipe / Муфта тип „Т” с вырезом для трубы

Index: MR-TH031-001

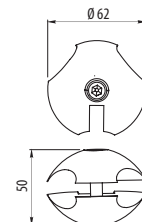

krata  
grating  
решетка

odbojnik silikonowy  
silicone stopper  
силиконовый амортизатор

połka szklana  
glass shelf  
стеклянная полка



ZnAl

material



color

## Złączka potrójna

Triple connector / Муфта тройная

Index: MR-TH002-.01

(prawy / lewy)  
(right / left)  
(правый / левый)

### Cechy produktu / Features / Характеристика товара:

- Dostępne wersje: lewa, prawa  
Available version: left, right  
Доступны варианты: левая, правая



ZnAl



color

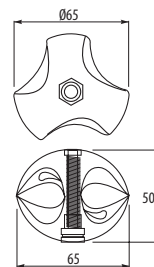

## Złączka podwójna

Double connector / Муфта двойная

Index: MR-TH018-.01

(prawy / lewy)  
(right / left)  
(правый / левый)

### Cechy produktu / Features / Характеристика товара:

- Dostępne wersje: lewa, prawa  
Available version: left, right  
Доступны варианты: левая, правая



ZnAl



color

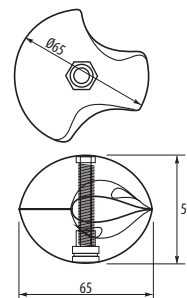

## Złączka do dwóch rur

Connector for two pipes / Соединитель для двух труб

Index: MR-TH033-001



ZnAl



color

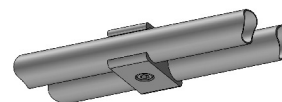
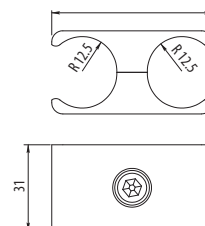

## Złączka do płyty i szkła\*

Connector for board and glass\* / Муфта для панели и стекла\*

Index: MR-TH009-001

### Cechy produktu / Features / Характеристика товара:

- \*Opcjonalna wkładka plastikowa umożliwia mocowanie półki szklanej (porównaj MR-THPLA-001 str. 27)
- \*Optional plastic insert allows to fasten a glass shelf (compare MR-THPLA-001 page 27)
- \*Дополнительная пластмассовая вкладка позволяет установить стеклянную полку (сравните MR-THPLA-001 сторона 27)



ZnAl

material

color



dla grubości płyty = 18 mm  
for board thickness = 18 mm  
для толщины плиты 18 мм

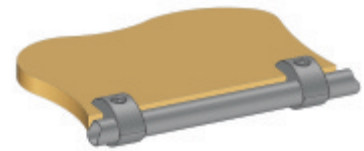
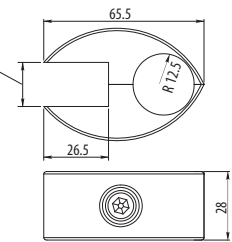

## Dwustronna złączka do płyty i szkła\*

Double-sided connector for board and glass\* / Двухстороннее крепление для панели и стекла\*

Index: MR-TH010-001

### Cechy produktu / Features / Характеристика товара:

- \*Opcjonalna wkładka plastikowa umożliwia mocowanie półki szklanej (porównaj MR-THPLA-001 str. 27)
- \*Optional plastic insert allows to fasten a glass shelf (compare MR-THPLA-001 page 27)
- \*Дополнительная пластмассовая вкладка позволяет установить стеклянную полку (сравните MR-THPLA-001 сторона 27)



ZnAl

material

color

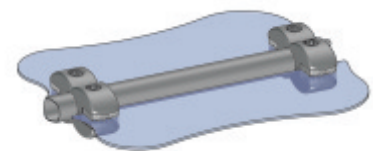
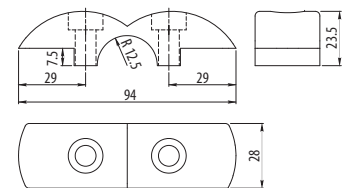

## Zestaw złączek do płyty i szkła\*

Connector for board and glass\* kit / Муфта для панели и стекла\* (комплект)

Index: MR-TH035-KPL

### Cechy produktu / Features / Характеристика товара:

- \*Opcjonalna wkładka plastikowa umożliwia mocowanie półki szklanej (porównaj MR-THPLA-001 str. 27)
- \*Optional plastic insert allows to fasten a glass shelf (compare MR-THPLA-001 page 27)
- \*Дополнительная пластмассовая вкладка позволяет установить стеклянную полку (сравните MR-THPLA-001 сторона 27)



ZnAl

material

color

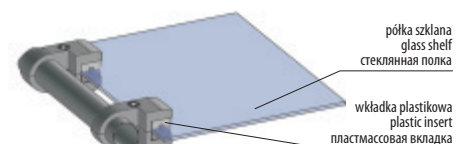
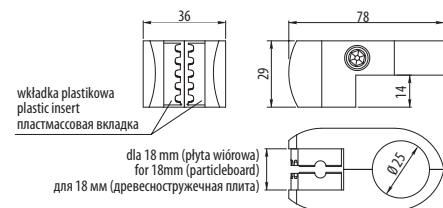

Możliwość zamocowania płyty wiórowej dla 18 mm (poprzez wyciągnięcie wkładki)  
The possibility of fixing particleboard for 18 mm (through drawing out an insert)  
Возможна установка ДСП плиты 18 мм (путем извлечения вкладки)

## Dwustronna złączka do szkła z mocowaniem do rury Ø25

Double-sided connector for glass with fixing to pipe / Крепление для панели двухстороннее

Index: MR-WP-14-KPL

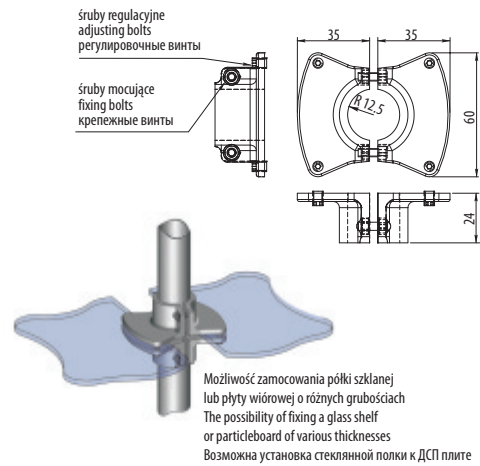

## Jednostronna złączka do szkła z mocowaniem do rury Ø25

Single-sided connector to glass with fixing to pipe / Крепление для панели одностороннее

Index: MR-WP-15-KPL

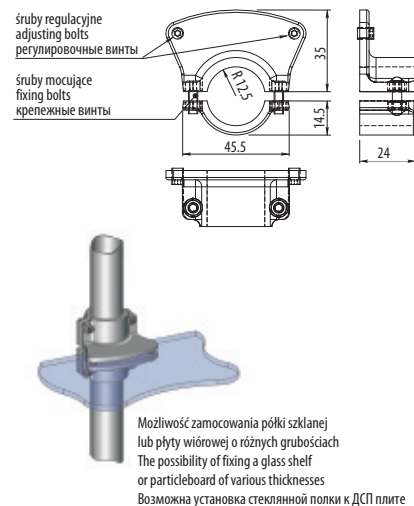

## Uchwyt dystansowy do rury Ø25 (przelotowy)

Distance handle / Крепление дистанционное

Index: MR-THA12-001

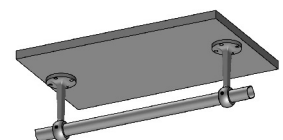
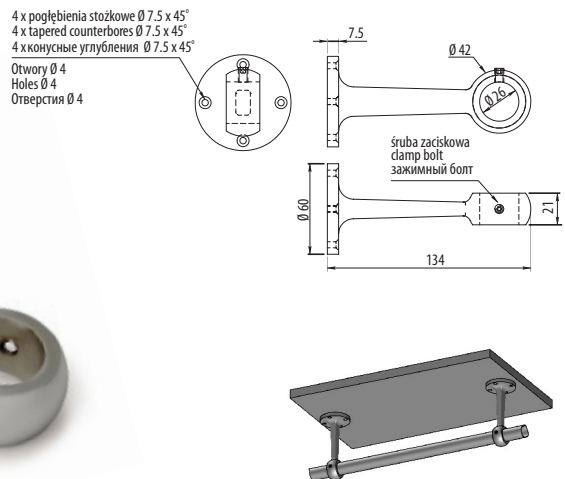

## Uchwyt dystansowy do rury Ø25

Closing distance handle (end) / Крепление дистанционное замыкающее

Index: MR-THB12-001



4 x pogłębienia stożkowe Ø 7.5 x 45°  
4 x tapered counterbores Ø 7.5 x 45°  
4 x конусные углубления Ø 7.5 x 45°

Otworki Ø 4  
Holes Ø 4  
Отверстия Ø 4

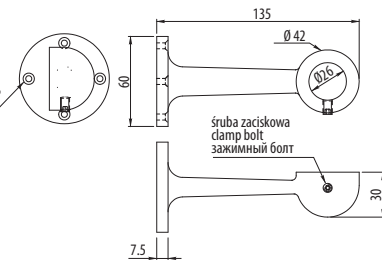

śruba zaciskowa  
clamp bolt  
закрепительный болт

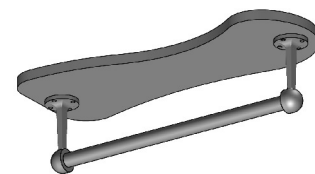

ZnAl

material



color

## Uchwyt dystansowy do rury owalnej

Angle bracket / Широкий угольник

Index: MR-WP-028-01

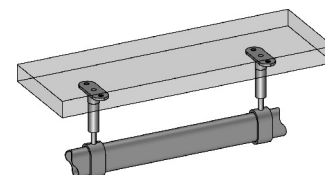
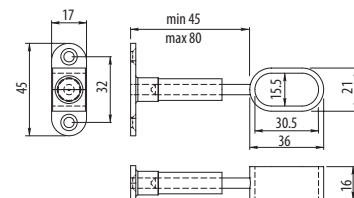

ZnAl

material



color

## Uchwyt dystansowy regulowany z zaślepką

Distance handle, adjustable, with plug / Крепление дистанционное замыкающее

Index: MR-WP-011-01

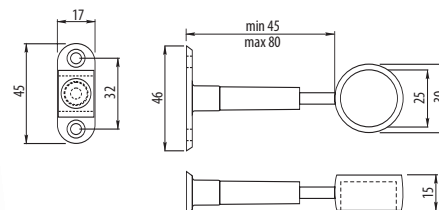

ZnAl

material



color

## Uchwyt dystansowy regulowany, przelotowy

Index: MR-WP-010-01

Distance handle, adjustable, clearance / Крепление дистанционное, сквозное

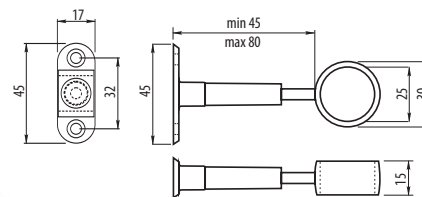

## Zaślepka okrągła do rury Ø25

Index: MR-THQZ1-001

Orb design cap for tube Ø 25 / Шар декоративный Ø 25

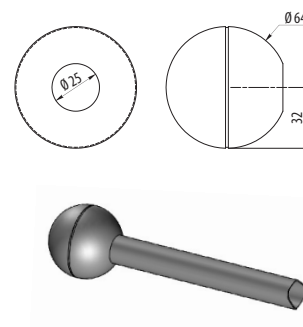

## Zaślepka do rury Ø 25

Index: MR-TH019-001

Plug for pipe Ø 25 / Заглушка для трубы Ø 25

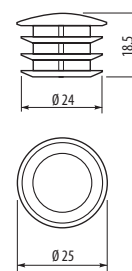
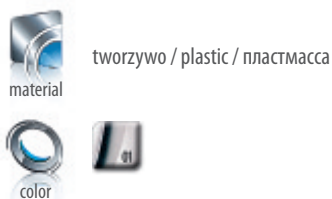

## Zaślepka półokrągła do rury Ø25

Index: MR-TH019-002

Semicircular cap Ø25 / Заглушка полукруглая Ø25

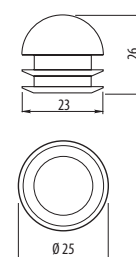

## Zaślepka do relingu z gwintem

Plug for railing with thread / Заглушка для релинга металлическая

Index: MR-WPZ023-01

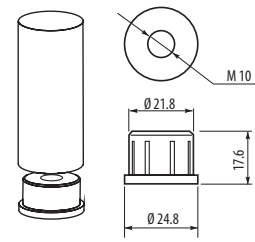

## Zaślepka z metalem

Plug with metal / Заглушка металлическая

Index: MR-WPF36-001

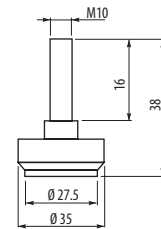
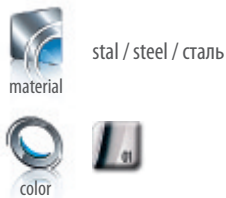

## Mocowanie typu U do rury Ø 25

Handle to boards / Крепление для панели

Index: MR-TH-088-01

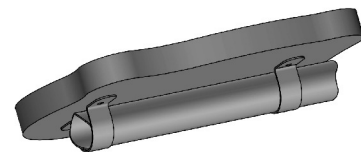
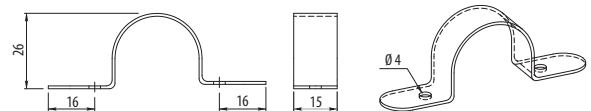

## Mocowanie kątowe do rury Ø25

Corner handle (saddle) / Крепление угловое

Index: MR-TH053-001

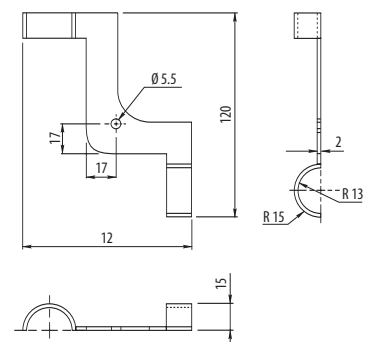

## Uchwyt do rury Ø25 z plastikową przyssawką

Index: MR-TH048-001

Horizontal steel handle for Glass with sucker (CHROME)

Горизонтальное крепление для стекла, металлическое, хромированное + присос



material

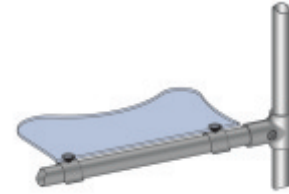
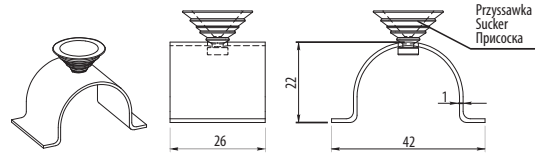

## Podpórka pozioma do rury do rury Ø 25

Index: MR-TH050-001

Horizontal handle for boards / Горизонтальное крепление для панели



material

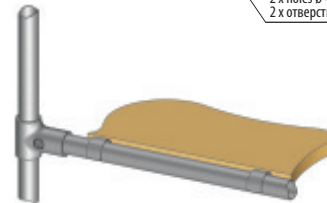
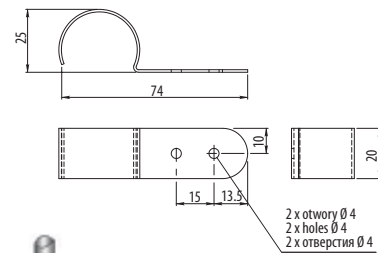

## Podpórka pionowa do rury Ø 25

Index: MR-TH051-001

Vertical support for pipe / Вертикальный полкодержатель для трубы



material

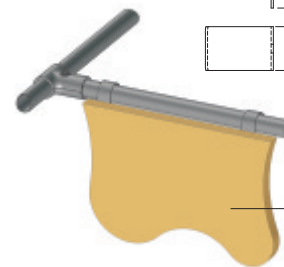

plyta wiórowa  
partideboard  
ДСП плита

## Stopka plastikowa zewnętrzna do rury Ø25

Index: MR-TH019-003

Outer plastic leg / Ножка пластмассовая внешняя



tworzywo / plastic / пластмасса

material



color

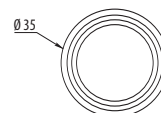
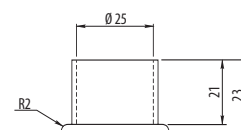

## Plastikowa wkładka do złączek do szkła

Plastic support connector for glass / Вкладка к WSR-7

Index: MR-THPLA-001

### Cechy produktu / Features / Характеристика товара:

- Element uzupełniający indexów: MR-TH035-KPL, MR-TH010-001, MR-TH009-001 (porównaj str. 21)  
The complementary indices: MR-TH035-KPL, MR-TH010-001, MR-TH009-001 (compare page 21)  
Дополнительный элемент индексов: MR-TH035-KPL, MR-TH010-001, MR-TH009-001 (Сравните страница 21)



tworzywo / plastic / пластмасса



## Tulejka maskująca Ø 50

Concealing sleeve / Маскировочная втулка

Index: MR-WPZ005-01



ZnAl

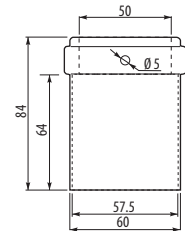

## Mocowanie górne rozporowe Ø 50

Expandable end support bracket / Верхнее крепление

Index: MR-WPZ006-01



stal + tworzywo  
steel + plastic  
сталь + пластмасса

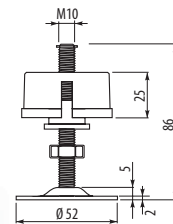

## Zaślepka do rury Ø 50

Concealing sleeve cap / Заглушка для трубы

Index: MR-WPZ001-01



ZnAl

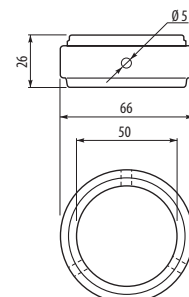

## Mocowanie boczne Ø 50

Centre rail support / Боковое крепление

Index: MR-WPZ004-01

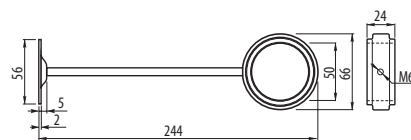

## Mocowanie dolne Ø 50

Bottom bracket / Нижнее крепление

Index: MR-WPZ002-01

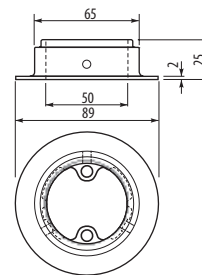

## Pierścień mocujący Ø 50

Rail ring / Маскировочное кольцо

Index: MR-WPZ003-01

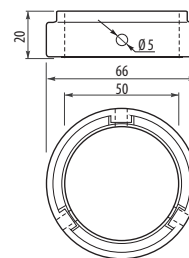

## Uchwyt do relingu prosty

Centre support / Ручка для релинга простая

Index: MR-WP2802-01

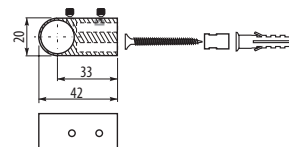
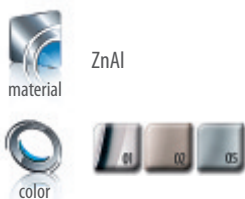

## Zaślepka do relingu retro

End cap / Заглушка для релинга ретро

Index: MR-WP2806-01



ZnAl + tworzywo  
ZnAl + plastic  
ZnAl + пластмасса

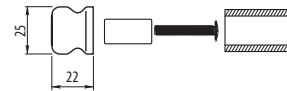

## Zaślepka do relingu prosta

End cap / Заглушка для релинга простая

Index: MR-WP2815-01



ZnAl



## Uchwyt do relingu retro

Centre support / Ручка для релинга ретро

Index: MR-WP2804-01



ZnAl

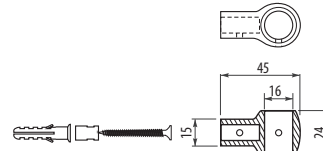

## Łącznik do relingu

Connector / Соединитель

Index: MR-WP2807-20



tworzywo / plastic / пластмасса

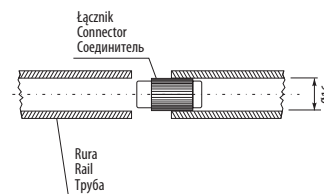

## Haczyk do relingu

Hook / Крючок

Index: MR-WPS01-001



stal / steel / сталь

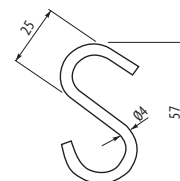

## Listwa boczna 28 mm

Work top strips / Торцевые планки

Index: LMB-BOCZ28-ALU

(prawy / lewy)  
(right / left)  
(правый / левый)

### Cechy produktu / Features / Характеристика товара:

- Dostępne wersje: lewa, prawa / Available version: left, right / Доступны варианты: левая, правая



material

aluminium / алюминий



color



03

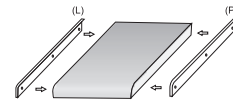
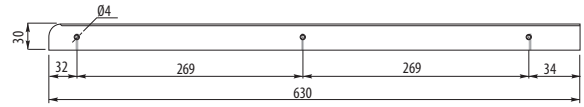

## Listwa kąтова 28 mm

Work top angle strips / Угловые планки

Index: LMB-KAT28-ALU

### Cechy produktu / Features / Характеристика товара:

- Dostępne wersje: lewa, prawa / Available version: left, right / Доступны варианты: левая, правая



material

aluminium / алюминий



color



03

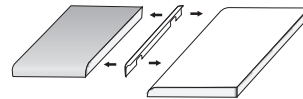
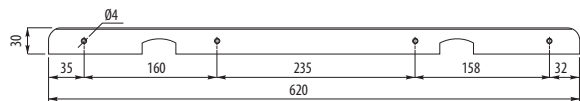

## Listwa szczelinowa 28 mm

Work top joining strips / Щелевые планки

Index: LMB-SZCZ28-ALU

### Cechy produktu / Features / Характеристика товара:

- Dostępne wersje: lewa, prawa / Available version: left, right / Доступны варианты: левая, правая



material

aluminium / алюминий



color



03

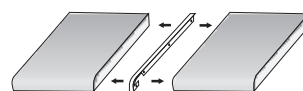
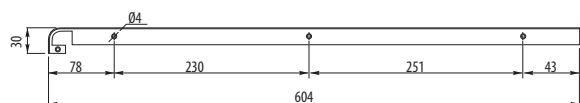

## Listwa boczna 38 mm

Work top strips / Торцевые планки

Index: LMB-BOCZ38-ALU

(prawy / lewy)  
(right / left)  
(правый / левый)

### Cechy produktu / Features / Характеристика товара:

- Dostępne wersje: lewa, prawa / Available version: left, right / Доступны варианты: левая, правая



aluminium / алюминий

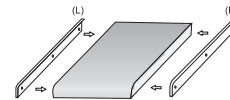
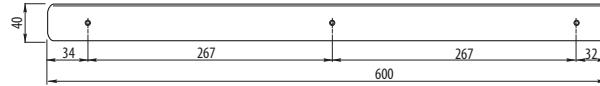

## Listwa kąтова 38 mm

Work top angle strips / Угловые планки

Index: LMB-KAT38-ALU

### Cechy produktu / Features / Характеристика товара:

- Dostępne wersje: lewa, prawa / Available version: left, right / Доступны варианты: левая, правая



aluminium / алюминий

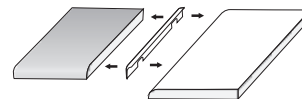
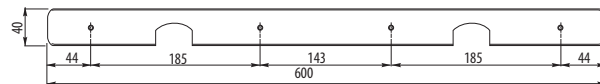

## Listwa szczelinowa 38 mm

Work top joining strips / Щелевые планки

Index: LMB-SZCZ38-ALU

### Cechy produktu / Features / Характеристика товара:

- Dostępne wersje: lewa, prawa / Available version: left, right / Доступны варианты: левая, правая



aluminium / алюминий

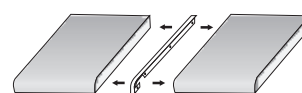
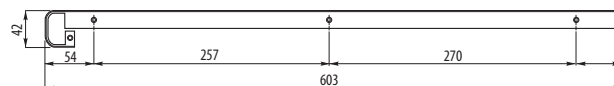

## Listwa boczna SU 28 mm

Work top strips / Торцевые планки

Index: LMB-SU-BOCZ28.-ALU

(prawy / lewy)  
(right / left)  
(правый / левый)

### Cechy produktu / Features / Характеристика товара:

- Dostępne wersje: lewa, prawa / Available version: left, right / Доступны варианты: левая, правая

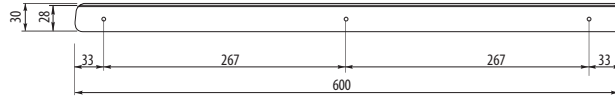

material

aluminium / алюминий



color



05

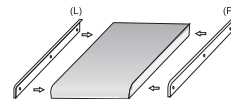

## Listwa kątowna SU 28 mm

Work top angle strips / Угловые планки

Index: LMB-SU-KAT28.-ALU

### Cechy produktu / Features / Характеристика товара:

- Dostępne wersje: lewa, prawa / Available version: left, right / Доступны варианты: левая, правая

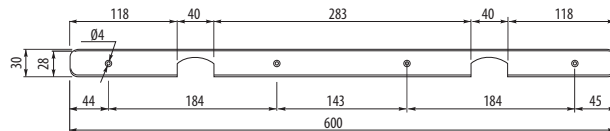

material

aluminium / алюминий



color



05

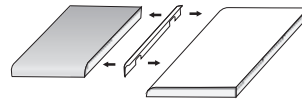

## Listwa szczelinowa SU 28 mm

Work top joining strips / Щелевые планки

Index: LMB-SU-SZCZ28.-ALU

### Cechy produktu / Features / Характеристика товара:

- Dostępne wersje: lewa, prawa / Available version: left, right / Доступны варианты: левая, правая

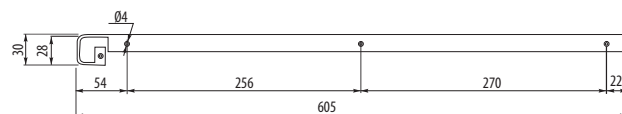

material

aluminium / алюминий



color



05

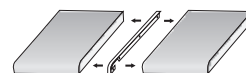

## Listwy podkładowe

Support strips / Профиль

Index: LO-PO-00-0..  
(color)



material

tworzywo / plastic / пластмасса



color



Taśma samoprzylepna  
Self-adhesive tape  
Скотч

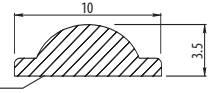

## Listwa ozdobna

Decorative strip / Декор

Index: LO-00-00-0..  
(color)



material

tworzywo / plastic / пластмасса



color



Taśma samoprzylepna  
Self-adhesive tape  
Скотч

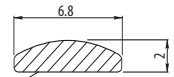

## Amortyzator silikonowy

Silicon cushion dots / Амортизатор силиконовый

Index: AMR-BP-0..-A  
(size)

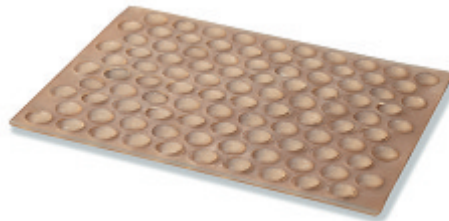

size

Ø 7 x 2 mm (arkusz 100 szt. / sheet 100 items / лист 100 шт.)  
Ø 9 x 3 mm (arkusz 80 szt. / sheet 80 items / лист 80 шт.)

## Szczotka przeciwkurzowa

Anti-dust strip / Щётка

Index: MR-SC6714-00



size

6.7 / 14

## Szczotka odbojnikowa

Runner strip / Щётка

Index: MR-SC48-5-00



size

4.8 / 5

## Obrotnica kwadratowa

Index: OM-OBK150-20

Square swivel bracket / Квадратная площадка под тв

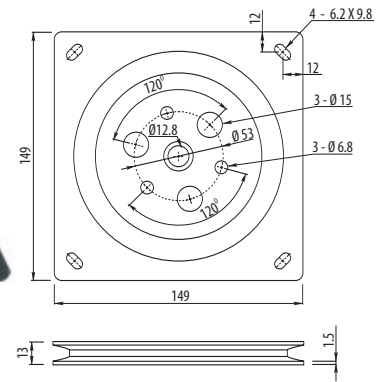

stal / steel / сталь



color

## Obrotnica okrągła

Index: OM-OBO...-05 (L1)

Round swivel bracket / Круглая площадка под тв

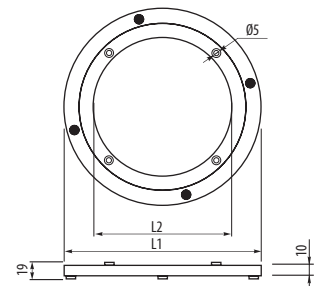

L1	L2
200	145
250	195
300	245
350	295
400	335



aluminium / алюминий

## Kratka wentylacyjna

Index: KK-W..800-0 (size) (model)

Plinth vent / Вентиляционная решётка

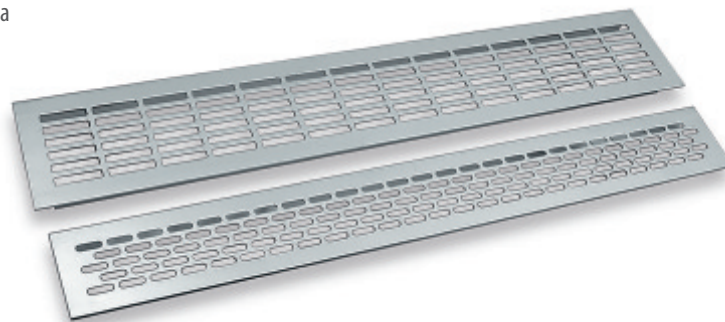

aluminium / алюминий



60 x 480, 80 x 480mm

size

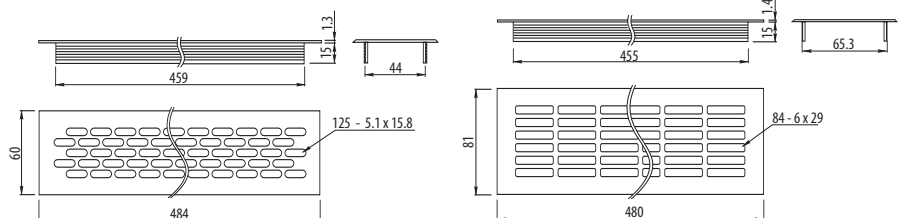

Index	Strona Page Страница	Index	Strona Page Страница	Index	Strona Page Страница	Index	Strona Page Страница
AMR-BP-0..-A	33	MR-TH051-001	26	MG-MENSA-0..	13	PP-XS0045-..	6
EM-SBL...-01	14	MR-TH053-001	25	MR-T1824-KPL	18	RR-CH-OW-000	16
LMB-BOCZ28.-ALU	30	MR-THQZ1-001	24	MR-TDL011-01	10	RR-.....H..	16
LMB-BOCZ38.-ALU	31	MR-THA12-001	22	MR-TH004-001	17	SZ-005-00-..	14
LMB-KAT28-ALU	30	MR-THB12-001	23	MR-TH005-001	17	SZ-008-00-..	14
LMB-KAT38-ALU	31	MR-THPLA-001	27	MR-TH014-001	16	WB-073024-..	12
LMB-SU-BOCZ28.-ALU	32	MR-WP-010-01	24	MR-TH016-001	18	WB-073026-..	12
LMB-SU-KAT28-ALU	32	MR-WP-011-01	23	MR-TH018-KPL	18	WB-WS-...-0..	11
LMB-SU-SZCZ28-ALU	32	MR-WP-028-01	23	MR-WP013-001	17	WK-CF....-01	14
LMB-SZCZ28-ALU	30	MR-WP-14-KPL	22	MR-ZSL011-01	10	WK-DO...-0..	14
LMB-SZCZ38-ALU	31	MR-WP-15-KPL	22	OM-OBK150-20	34	ZK-R1-KPL-10	13
LO-PO-00-0..	33	MR-WP2802-01	28	OM-OBO...-05	34	ZK-STRONG-.1	13
LO-00-00-0..	33	MR-WP2804-01	29	PP-DP0047-..	7	ZK-ZAS-.0-10	13
MR-SC48-5-00	33	MR-WP2806-01	29	PP-DP0066-..	7	ZZ-BA-SK0-01	5
MR-SC6714-00	33	MR-WP2807-20	29	PP-DP0097-..	8	ZZ-B0-105-01	2
MR-TH-088-01	25	MR-WP2815-01	29	PP-DP0105-..	7	ZZ-CF-138-01	1
MR-TH001-001	19	MR-WPF36-001	25	PP-HS0006-01	10	ZZ-C-.288-01	5
MR-TH002-.01	20	MR-WPS01-001	29	PP-HS2710-..	9	ZZ-G0-328-01	4
MR-TH009-001	21	MR-WPZ001-01	27	PP-HS2713-..	9	ZZ-KLMASTER	1
MR-TH010-001	21	MR-WPZ002-01	28	PP-LUK-00...	12	ZZ-KLREMOVAL	1
MR-TH011-001	19	MR-WPZ003-01	28	PP-MP055-..	6	ZZ-KM-138-01	1
MR-TH018-.01	20	MR-WPZ004-01	28	PP-00GS01-..	8	ZZ-M0-201-01	4
MR-TH019-001	24	MR-WPZ005-01	27	PP-00GS02-..	8	ZZ-SZ-407-..	3
MR-TH019-003	26	MR-WPZ006-01	27	PP-00GS03-..	9	ZZ-SZ-408-..	3
MR-TH019-002	24	MR-WPZ023-01	25	PP-00GS04-..	9	ZZ-SZ-409-..	3
MR-TH031-001	19	KK-W..800-0	34	PP-SMART-000	11	ZZ-ZN-138-01	1
MR-TH033-001	20	KW-FS01..-01	15	PP-SOL003-01	10	ZZ-ZN-338-01	2
MR-TH035-KPL	21	KW-FS03..-01	15	PP-SOL012-01	10	ZZ-Z0-202-01	4
MR-TH048-001	26	KW-FS04..-00	15	PP-SP0075-..	6	ZZ-...-103-01	2
MR-TH050-001	26	KW-FS0650-01	15	PP-SPL001-..	11		

**Pokrycia galwaniczne / Galvanic coatings**  
Шаблон гальванических покрытий

- 01  chrom / chrome / хром
- 02  satyna / satin / сатин
- 03  mosiądz / brass / золото
- 04  stary mosiądz / antique brass / старое золото
- 05  aluminium / алюминий
- 06  stal szcztokowana / brushed steel / шлифованная сталь

**Pokrycia lakiernicze / Enamel coatings**  
Шаблон лакированных покрытий

- 10  biały / white / белый
- 20  czarny / black / чёрный